



**THE
PREVENTIVE
MAINTENANCE
MONTHLY**

ISSUE 791 OCTOBER 2018



COMBAT VEHICLES 2

- M1-Series Tanks, Final Drive Checks 2-3
- M2/M3-Series Bradley, Transmission Oil Dipstick Gasket 4
- M2/M3-Series Bradley, Loose Idler Wheel Nuts 5
- M88A2 Recovery Vehicle, Use Tarp to Protect Engine 6
- M88A2 Recovery Vehicle, Engine Oil Check Before and After Operations 7
- M113-Series FOV, Drain Hull Water to Stop Rust 8
- M109A6 Paladin, Cannon Tube Travel Lock Friction Lining Replacement 9



TACTICAL VEHICLES 10

- Rust Busters Tip of the Month 10-14
- Tire Shine Products Unauthorized 15



CONSTRUCTION 16

- Backhoe Loader Operation Safety Tips 16-17
- Backhoe Loader, Prime Turbocharger Before Startup 18
- M1272 Buffalo, Walking Beam Rubber Bushings Check 19
- 6K VRRF Forklift Mod Kit for Engine Upgrade 20



AVIATION 21

- IHADSS Visor Housing Display Replacement 21
- Air Warrior, Crew Restraint Assembly Being Fielded 22-24
- AH-64D/E, Improved ECS Filter Duct Assembly 25
- H-60A/L, IMMSS Litter Platform Turn-in Needed 26

Presenting James Bondo in Moonbreaker - Part 1 27-34



CBRN 35

- NBCRV Stryker PM Tips 35-37
- M26 Decon Water Pressure Gauge Calibration 37



TOOLS 38

- M7 FRS Loading/Unloading Tips 38-39
- M7 FRS Door Latch NSN 39



MISSILES 40

- M1134 ATGM Stryker, Basic Skill Trainer Tips 40
- M240B Machine Gun, Protect from HIMARS Exhaust 41



SMALL ARMS 42

- Small Arms Maintenance Tips from Ft Bragg LRC 42-43
- M240-Series Machine Gun, Adjustable Buttstock Parts 44
- M2A1 Machine Gun Barrel Installation 44-45



COMMUNICATIONS 46

- Generator Licensing Requirements 46-47
- Satellite Transportable Terminal (STT) TM Released 47
- PAAWNS TM Available 47
- COMSEC Legacy Equipment Turn-in Guidance 48-51



SOLDIER SUPPORT 52

- MTRCS PM Tips 52-53
- Fire Extinguisher Recall Notice 54-55
- ECH Helmets with Sensors Turn-in 55
- Mobile Kitchen Trailer (MKT) MELs Updated 56



LOGISTICS MANAGEMENT 57

- AMSAA Offers Bench and Shop Stock Advice 57
- 2018 Army Award for Maintenance Excellence Entries 58
- Greenwich Mean Time Made Easy 58-59
- Hand Receipt BOM Discrepancy Reporting 60
- GCSS-A Supply Smartbook Download 60

Connie's Post Scripts 61

TB 43-PS-791, *The Preventive Maintenance Monthly*, is an official publication of the Department of the Army, providing information for all Soldiers assigned to combat and combat support units and all Soldiers with unit maintenance and supply duties. All information published has been reviewed and approved by the authority responsible for the equipment, publication or policy discussed. Application of the information is optional with the user. Masculine pronouns may refer to both genders. The use of product or company names does not constitute endorsement of those products, services or companies by the U.S. Army. The use of non-DoD hyperlinks, along with their content, does not constitute endorsement by DoD or DA. Neither DoD nor DA exercises any editorial control over, and cannot vouch for, content on non-DoD websites.

PS, The Preventive Maintenance Monthly (ISSN 0475-2953)
is published monthly by the Department of the Army, Redstone Arsenal, AL 35898.

You are invited to send PS your ideas for improving maintenance procedures, questions on maintenance and supply problems and questions or comments on material published in PS.

Just write to:
MSG Half-Mast
PS, the Preventive Maintenance Monthly
USAMC LOGSA (AMXLS-GP)
Bldg. 3303
Redstone Arsenal, AL 35898

Or email:
usarmy.redstone.logsa.mbx.psmag@mail.mil

Internet address:
https://www.logsa.army.mil/psmag/pshome.cfm

By Order of the Secretary of the Army:

MARK A. MILLEY
General, United States Army
Chief of Staff

Official:

MARK F. AVERILL
Acting Administrative Assistant
to the Secretary of the Army
182855

Issue 791

PS

October
2018

THE PREVENTIVE MAINTENANCE MONTHLY

TB 43-PS-791

Approved for
Public Release;
Distribution is
Unlimited

OH, NO! THE
CORROSION
MONSTERS
ARE HERE!

YOU GOTTA
PROTECT US!

WE WILL!
PS RUSTBUSTERS
TIPS CAN KNOCK
THESE GUYS OUT!

FOR MORE INFO,
SEE PAGES 10-14!

Next-Gen Needs PMCS, Too

REPORTING FOR DUTY, SIR!

WELCOME TO THE TEAM, JLTV!



THERE'S A LOT OF DISCUSSION THESE DAYS ABOUT THE **NEXT GENERATION**. NEW WORKHORSES LIKE THE **JOINT LIGHT TACTICAL VEHICLE (JLTV)** ARE SCHEDULED TO BEGIN FIELDING IN 2019.

THEN THERE'S THE ARMY'S **NEXT-GENERATION COMBAT VEHICLE (NGCV)** THAT'S STILL ON THE DRAWING BOARD BUT EXPECTED TO BE READY FOR SOLDIER EVALUATIONS BY 2020.



NEW VEHICLES AND EQUIPMENT REQUIRE TRAINING AND ORIENTATION, BUT YOU CAN BET THESE NEXT-GEN MODELS WILL STILL RELY HEAVILY ON **PMCS**. THEIR **PMCS CHECKLISTS** MAY BE **DIFFERENT** FROM ANYTHING YOU'VE SEEN, BUT THE CONCEPT OF PREVENTIVE MAINTENANCE **WON'T** CHANGE.

THAT'S BECAUSE **PMCS** ENABLES SOLDIERS TO GET THE **BEST PERFORMANCE** OUT OF THEIR EQUIPMENT AND VEHICLES.

AS ANY SOLDIER KNOWS, EQUIPMENT RELIABILITY IS **CRUCIAL** IN THE FIELD.

WHETHER THEY'RE **NEXT-GEN** OR **OLD STANDBYS**...

...RELY ON **PMCS** TO KEEP YOUR EQUIPMENT **AND** VEHICLES OPERATING AT **PEAK PERFORMANCE**.

AND RELY ON **PS** MAGAZINE TO BRING YOU THE **LATEST MAINTENANCE TIPS** FOR **NEXT-GEN** AND **OLD STANDBYS!**

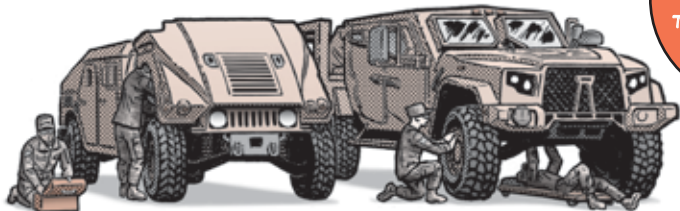

DON'T Neglect Final Drive PM!

I THINK THAT'S ENOUGH PM FOR THIS WEEK!

MAN, AM I READY FOR THE WEEKEND!

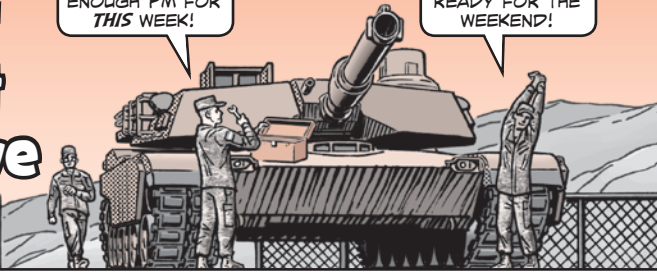

HANG ON, SOLDIERS! YOU'RE NOT DONE JUST YET!



UH, WHADDYA MEAN?



YOU DIDN'T CHECK THE OIL IN THE FINAL DRIVES. YOU'RE NOT DONE UNTIL THAT'S DONE!

WHAT'S SO IMPORTANT ABOUT CHECKING THAT, MASTER SERGEANT?



FINAL DRIVES THAT RUN OUT OF OIL WILL SEIZE AND LOCK UP THE TRANSMISSION. THE REPAIRS WILL COST YOUR UNIT BIG BUCKS.

NOT TO MENTION YOU'LL BE EXPLAINING TO YOUR COMMANDER WHY YOU NEVER CHECKED YOUR TANK'S FINAL DRIVES!



WHOA! I SURE DON'T WANNA HAVE TO DO THAT!

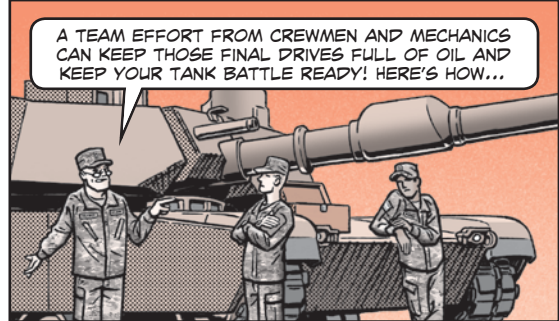

A TEAM EFFORT FROM CREWMEN AND MECHANICS CAN KEEP THOSE FINAL DRIVES FULL OF OIL AND KEEP YOUR TANK BATTLE READY! HERE'S HOW...

Crewmen

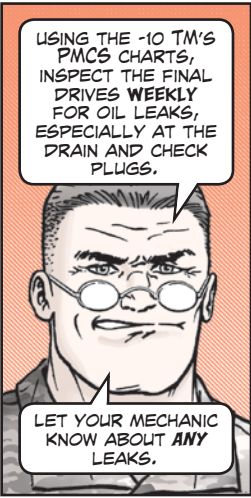

USING THE -10 TM'S PMCS CHARTS, INSPECT THE FINAL DRIVES WEEKLY FOR OIL LEAKS, ESPECIALLY AT THE DRAIN AND CHECK PLUGS.

LET YOUR MECHANIC KNOW ABOUT ANY LEAKS.

WHILE YOU'RE AT IT, CHECK OUT THE FINAL DRIVE FILLER CAP. DIRT, OIL AND SAND CAN CLOG THE VENT HOLE ON EACH OF THE FILLER CAPS. WHEN THAT HAPPENS, PRESSURE CAN BUILD UNTIL THE FINAL DRIVE SEAL RUPTURES.

IF YOU'RE OPERATING IN A DUSTY OR MUDDY ENVIRONMENT, CHECK THE FILLER CAP AFTER EVERY MISSION!

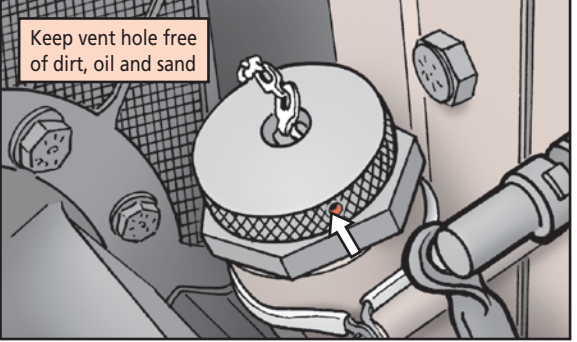

Keep vent hole free of dirt, oil and sand

Mechanics

AFTER CHECKING THE FINAL DRIVE OIL LEVELS DURING SEMIANNUAL SERVICES, MAKE SURE YOU USE THE RIGHT TORQUE WHEN REPLACING THE DRAIN AND CHECK PLUGS.



THE PLUGS LOOK THE SAME, BUT THEY DON'T TAKE THE SAME TORQUE.

THE CHECK PLUG IS TIGHTENED TO 40-50 LB-FT. BUT THE DRAIN PLUG CAN'T TAKE THAT KIND OF PRESSURE. IT EITHER CRACKS-AND LEAKS-OR SHEARS OFF ALTOGETHER.

MAKE SURE YOU TORQUE THE DRAIN PLUG TO 120-180 LB-IN. YES, THAT'S POUND-INCH!

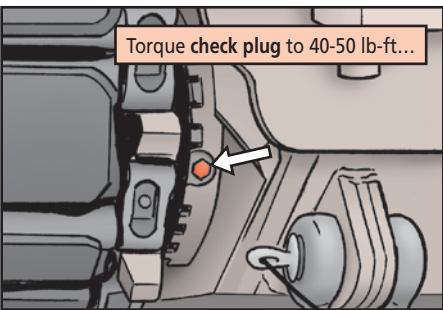

Torque check plug to 40-50 lb-ft...

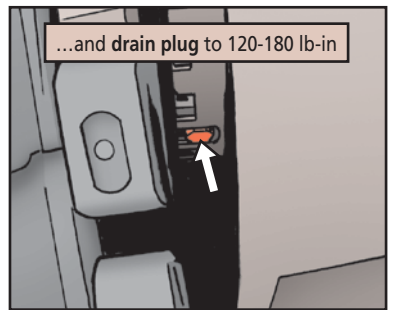

...and drain plug to 120-180 lb-in

YOU'LL FIND THE STEP-BY-STEP INSTRUCTIONS IN THE -23 TMS FOR THE M1A1 AND TM 9-2350-388-13&P ON IETM EM 0334 FOR THE M1A2.

LOOKS LIKE THE
TRANSMISSION IS
SHOT!

Little Gasket Can Cause BIG Problem

WHAT
COULDA
CAUSED
THAT?



Sometimes the smallest thing can cause the biggest headaches, like the gasket under the top of your Bradley's transmission oil dipstick.

The dipstick's outta sight so you likely don't give it a second thought. But you should, 'cause if that gasket is damaged or worn, the transmission could be in for some serious trouble.

You have to turn the T-handle on the dipstick to lock it in place after checking the transmission oil. Turning the T-handle squeezes the gasket under the top of the dipstick to seal the opening.

But don't turn the T-handle too tight. If the gasket is damaged or missing, you won't get a good seal. Water, dirt and sand can get past the seal and into the transmission, contaminating it. Replacing a transmission isn't cheap. And until it's replaced, your Bradley is NMC and unit readiness suffers.

So easy does it when turning the T-handle. And be sure to eyeball the dipstick seal after checking the oil level. If it's cut, torn or missing, get a new dipstick with NSN 6680-01-180-5640.

Too tight on T-handle will damage gasket

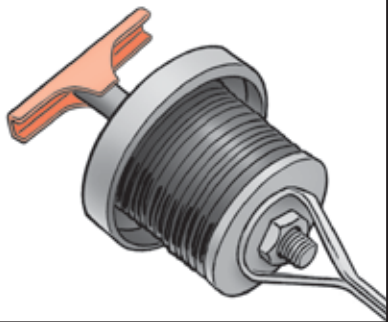

Avoid an Idler Wheel Breakaway!



WHOA! THIS ROUGH STUFF IS GONNA BE TOUGH ON MY IDLER WHEEL NUTS!

Dear Editor,

One after-operations check for the Bradley that gets overlooked a lot is for the idler wheel nuts.

Rough field operations can loosen the idler wheel nuts. Once one nut loosens, it puts pressure on the other nuts until they loosen, too. Enough loose nuts can cause the wheel to wobble or even break loose from the vehicle!

Check those idler wheel nuts after every operation. Look for a shiny area under the nut where it's rubbed against the wheel. Ask your mechanic to replace any loose nuts with NSN 5310-00-175-2710 and torque them to 170-200 lb-ft.

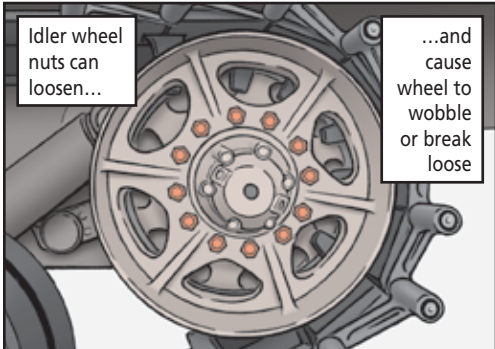

Idler wheel nuts can loosen...

...and cause wheel to wobble or break loose

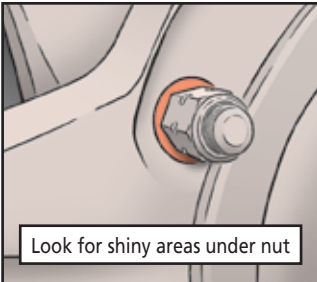

Look for shiny areas under nut

It's OK to tighten any loose nuts while you're in the field. Just be sure to mark which nuts were loose so your mechanic can replace them when you get back to the motor pool.

CW2 Doug Byner
Ft Carson, CO

Editor's note: *These tips will keep your idler wheels working hard. Thanks, Chief!*

DON'T LET RAIN SINK YOUR ENGINE!

YOU DON'T LOOK HAPPY.

I NEED MORE RAIN PROTECTION THAN THIS, PAL!

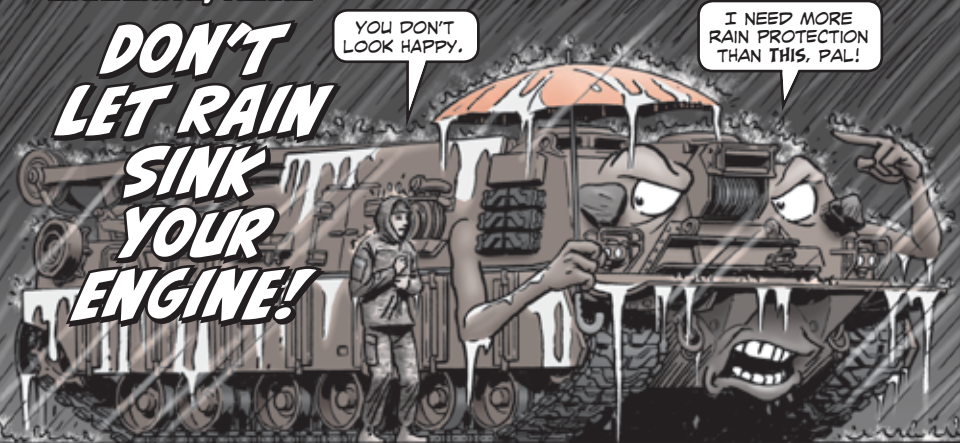

IF YOUR M88A2 RECOVERY VEHICLE WILL BE SITTING IN THE MOTOR POOL FOR A WHILE, A FEW PRECAUTIONS WILL HELP PROTECT THE ENGINE.

LIKE IT SAYS IN THE -10 TM, IF YOUR VEHICLE WILL BE PARKED FOR LONGER THAN TWO WEEKS:

- open the hull drains
- remove the hull access plates
- cover the engine deck with a tarp.

THAT'LL PREVENT RAIN FROM FILLING THE ENGINE COMPARTMENT AND DAMAGING COMPONENTS LIKE THE STARTER AND WIRING HARNESS.

BETTER YET, ORDER A TARP THAT'S BIG ENOUGH TO COVER THE **ENTIRE VEHICLE!**

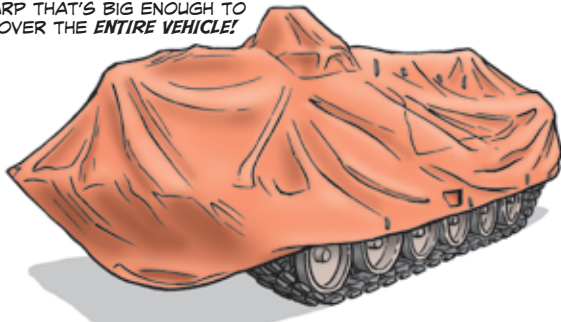

Full vehicle tarp protects entire vehicle, including engine, from rain

GET A TAN TARP WITH NSN 2540-01-578-4446 OR A GREEN TARP WITH NSN 2540-01-578-3927.

THE TAN TARP WILL SET YOUR UNIT BACK ABOUT \$2,500 AND THE GREEN TARP ABOUT \$2,000.

THAT'S A BARGAIN COMPARED TO \$500,000 FOR A NEW ENGINE!



M88A2 Recovery Vehicle...

WHAT'S THE DEAL WITH HIM?

SHH! DON'T WAKE HIM... HE'S JUST HANGING OUT UNTIL IT'S TIME TO CHECK MY ENGINE OIL!

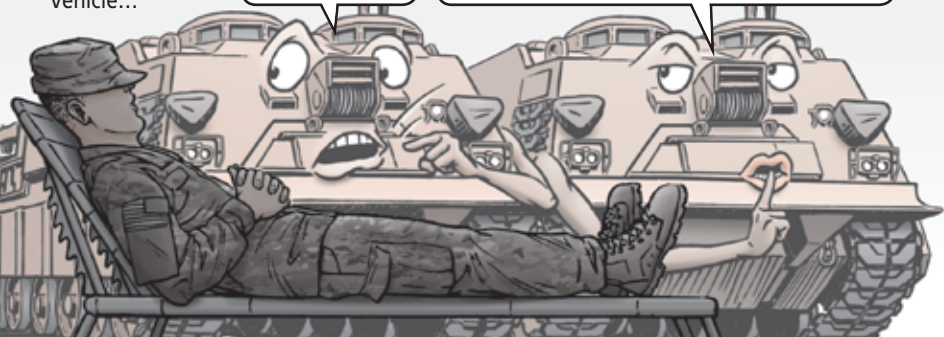

OIL CHECK? NOT SO FAST!



IT'S SAID THAT **PATIENCE IS A VIRTUE**. THAT'S ESPECIALLY TRUE WHEN IT COMES TO CHECKING THE ENGINE OIL LEVEL ON YOUR M88A2 RECOVERY VEHICLE.

ALWAYS WAIT AT LEAST TWO HOURS AFTER SHUTDOWN BEFORE CHECKING THE ENGINE OIL LEVEL. THAT ALLOWS TIME FOR ALL THE OIL TO **DRAIN BACK DOWN** FROM THE ENGINE.

SOMETIMES OPERATORS CHECK IT **TOO SOON**. SINCE THE READING IS LOW, THEY ASSUME MORE OIL SHOULD BE ADDED TO BRING THE LEVEL UP.

INSTEAD, THEY'RE ADDING TOO MUCH OIL.

AT THE NEXT STARTUP, THAT EXCESS ENGINE OIL IS FORCED UP THROUGH THE CRANKCASE VENTILATION PIPE AND INTO THE TURBOCHARGER.

THE TURBOCHARGER'S EXTREME HEAT IGNITES THE OIL AND FLAMES SHOOT OUT THE RIGHT-SIDE EXHAUST STACK.

THAT'S DANGEROUS!

During Operations Oil Check



THERE'S **ONLY ONE** TIME IT'S OK TO CHECK THE ENGINE OIL **WITHOUT** WAITING TWO HOURS AFTER SHUTDOWN. THAT'S DURING EXTENDED OPERATIONS, WHEN IT'S **NOT POSSIBLE** TO SHUT DOWN THE ENGINE FOR THAT LONG.

IN THAT CASE, YOU CAN CHECK THE OIL LEVEL **AFTER** THE ENGINE HAS BEEN IDLING FOR **AT LEAST FIVE MINUTES** AND IS AT NORMAL OPERATING TEMPERATURE.

AS LONG AS THE LEVEL IS **NO MORE** THAN ONE GALLON LOW OR ONE GALLON HIGH, YOUR ENGINE IS GOOD TO GO.

THEN DO A COLD CHECK AS SOON AS THE MISSION ALLOWS, MAKING SURE THE ENGINE HAS BEEN SHUT DOWN FOR AT LEAST TWO HOURS.

PLUG UP HULL RUST PROBLEMS

WHAT THE HECK???

P-PULL MY HULL D-DRAIN PLUGS-

NOW!

CREWMEN, IF WATER GETS IN THE HULL OF YOUR M113-SERIES VEHICLE, YOU MIGHT FIND YOUR NEXT MISSION A VERY SOGGY AFFAIR!

RAIN AND WATER FROM THE WASH RACK CAN RUST THE FUEL LINE AND RAMP PUMP FITTINGS UNDER THE FLOOR PLATES. NEXT THING YOU KNOW, LEAKS ARE SPRING UP EVERYWHERE AND YOUR VEHICLE IS OUT OF ACTION.

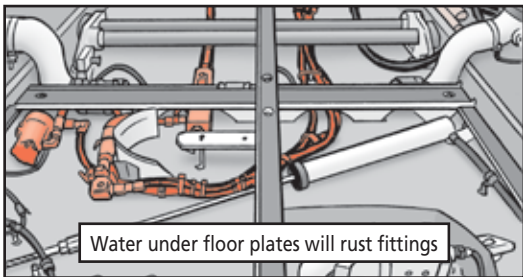

Water under floor plates will rust fittings

BUT WITH A LITTLE CARE AND DILIGENCE, YOU CAN DAM UP WATER DAMAGE BEFORE IT BEGINS.

START WITH THE THREE HULL DRAIN PLUGS, NSN 2590-00-299-0739, ON THE BOTTOM OF YOUR VEHICLE—TWO AT THE FRONT AND ONE AT THE BACK. JUST OPEN THE PLUGS AND WATCH YOUR WATER WOES GO DOWN THE DRAIN.

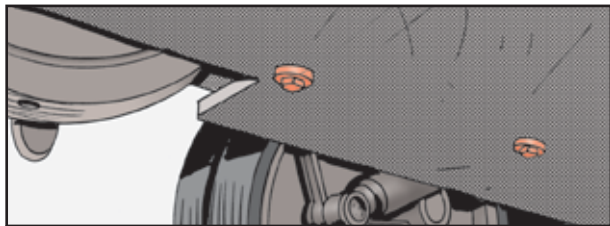

Open all three hull drain plugs to drain water (third plug not shown)

MAKE SURE THAT YOU REINSTALL THE PLUGS AFTER THE HULL HAS DRAINED.

FOLLOW YOUR UNIT'S SOP ON WHERE TO DRAIN THE HULL—MOST LIKELY AT THE WASH RACK—SINCE THE WATER IS SURE TO BE CONTAMINATED WITH FUEL, OIL, HYDRAULIC FLUID OR OTHER MATERIALS THAT ARE CONSIDERED **HAZARDOUS WASTE**.

YOU MIGHT BE ABLE TO USE DRIP PANS IF THE WATER LEVEL IS LOW. THEN DISPOSE OF THE WASTE-WATER PROPERLY.

Check Those Friction Linings



WHAT'S THE BIG IDEA WITH THE PILLOW?

I WOULDN'T NEED THIS IF YOU'D REPLACE THE FRICTION LININGS ON MY TRAVEL LOCK!

Dear Editor,

Of all the things Paladin crews need to check out during PMCS, one of the easiest to overlook is the cannon tube's travel lock friction linings.

The Friction linings cushion the tube when it's in the travel lock, keeping metal from rubbing and scraping on metal. When linings are missing, a lot of damage gets done to the cannon tube.

So check the linings and have your mechanic replace them if necessary. That's a lot easier and cheaper than replacing a cannon tube.

Mechanics, replace the **bottom lining** with NSN 2530-01-354-0400 and the **top lining** with NSN 2530-01-354-0401. Remove the old linings and adhesive residue with a wire brush.

Apply **new adhesive**, NSN 8040-01-484-0416, to the replacement linings using an **acid swabbing brush**, NSN 7920-00-514-2417.

Install the new linings and leave the travel lock open and unused for at least one hour so the adhesive can dry.

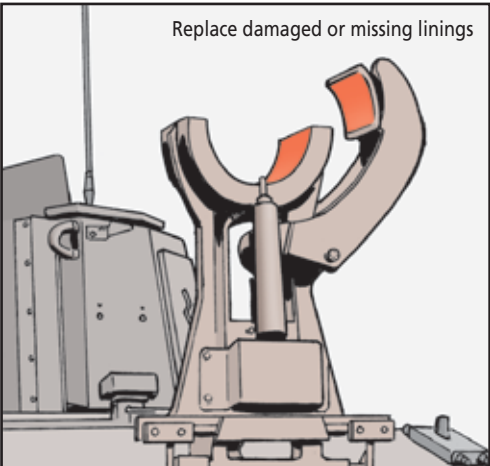

Replace damaged or missing linings

CW2 David Bradley
Ft Bliss, TX

Editor's note: Crews, this tip will keep you from catching friction from your commander!

RUST BUSTERS

TIP OF THE MONTH

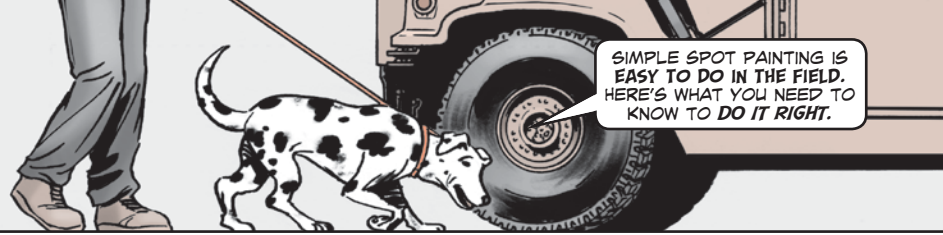

Before You Start

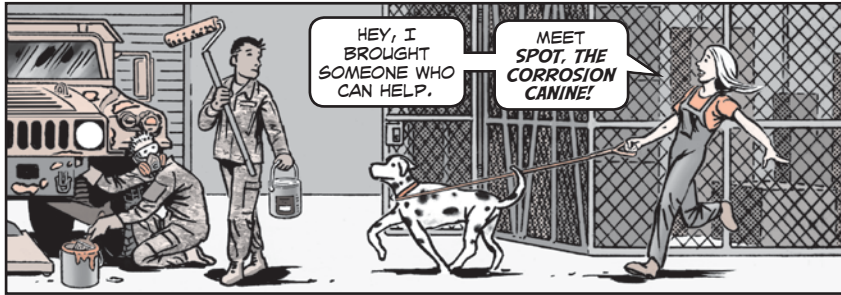
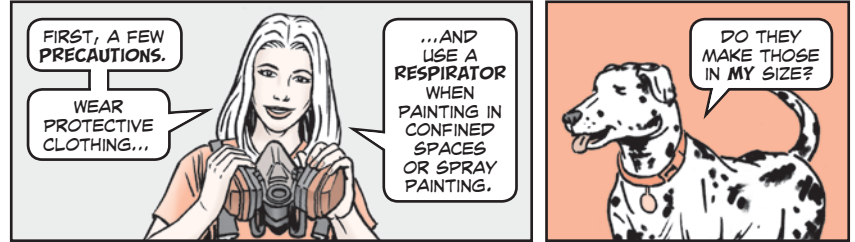

START WITH A CLEAN DRY SURFACE THAT'S BEEN PROPERLY PREPPED BY REMOVING ALL DIRT, GREASE, LOOSE RUST AND PEELING PAINT.

SEE PAGES 11-13 OF PS 790 (SEP 18), FOR MORE DETAILS ON PREPPING SURFACES:
<https://www.logsa.army.mil/web2/archive/PS2018/790/790-11-13.pdf>



TIP #1 A properly prepped surface is clean, dry and smooth

A SCRATCH HERE, A CHIP THERE AND SOON...
 ...THE CHEMICAL AGENT RESISTANT COATING (CARC) PAINT ON YOUR VEHICLE IS DAMAGED.

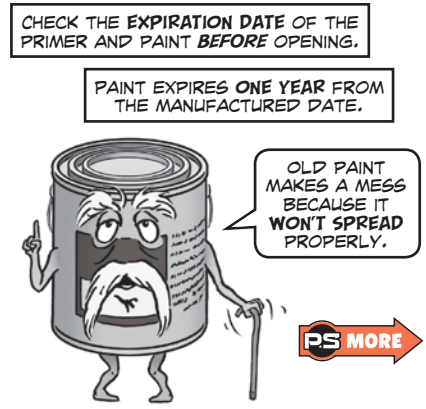
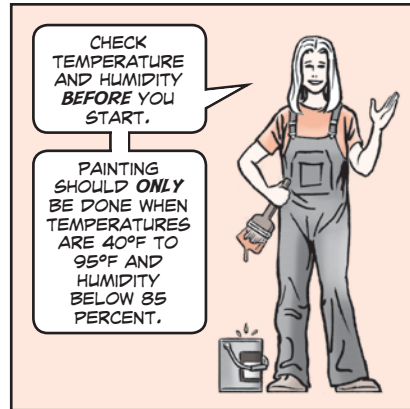
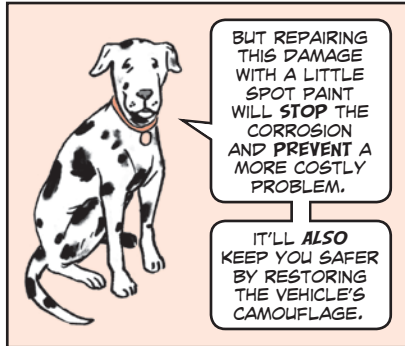
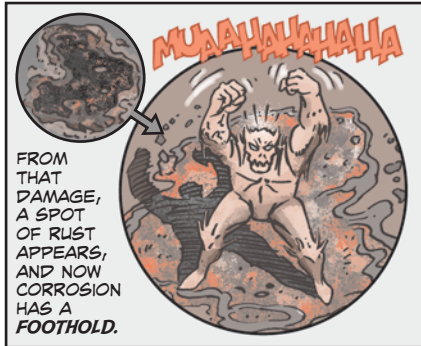

Priming

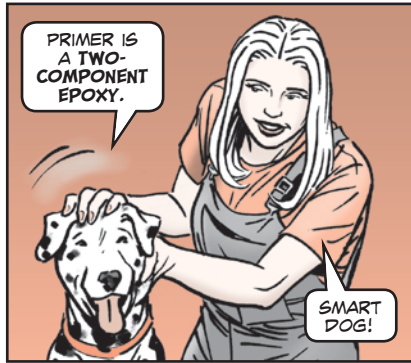

UNLESS YOU USE AEROSOL PRIMER, YOU'LL HAVE TO MIX THE COMPONENTS USING THE RATIOS IN THE DIRECTIONS, THEN WAIT FOR THE TIME SPECIFIED. THIS ALLOWS THE CHEMICALS TO REACH THE RIGHT STAGE FOR APPLICATION.

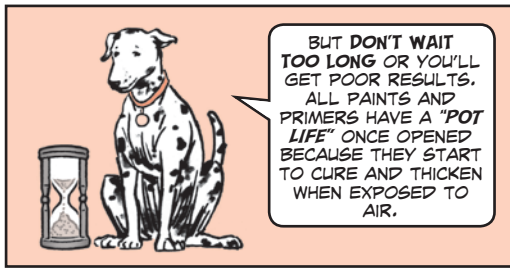

TIP #2 A quart of primer covers about 100 square feet

APPLY THIN LAYERS OF PRIMER USING A BRUSH OR ROLLER. OVERLY THICK COATS MAY CRACK, SO CHECK WITH A WET FILM THICKNESS GAGE, NSN 5210-01-467-1903. THE PRIMER AND PAINT MANUFACTURERS WILL LIST THE APPROPRIATE WET FILM THICKNESS ON THEIR PACKAGING. PROTECT THE SURFACE AND WAIT 30 TO 90 MINUTES BEFORE APPLYING THE TOPCOAT.

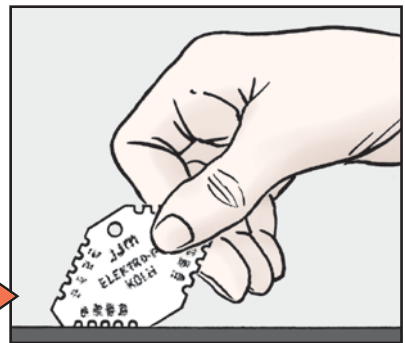

TIP #3 Use wet film thickness gage to check primer/paint

Painting Topcoat



PREPARE THE TOPCOAT BY STIRRING TO A SMOOTH CONSISTENCY.

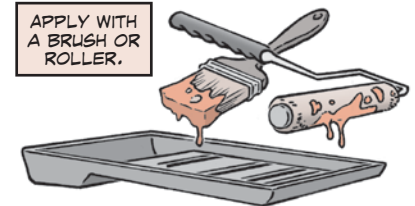

THE TOPCOAT IS ALSO AVAILABLE AS AN AEROSOL AND IN BOTTLES WITH ROLLER AND BRUSH APPLICATORS.

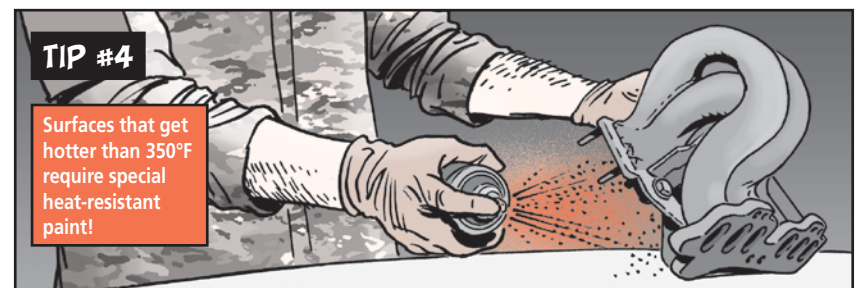
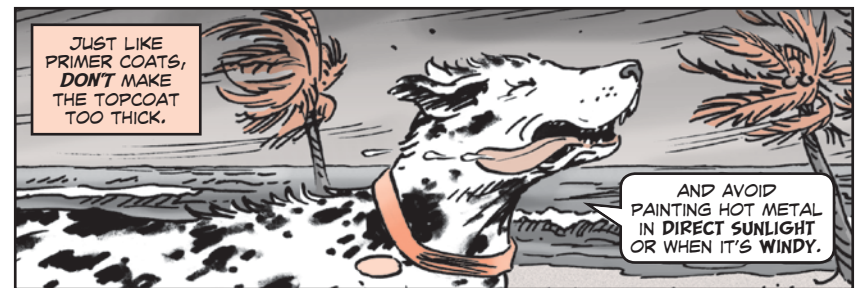

ADDITIONAL GUIDANCE ON SURFACE PREP AND SPOT PAINTING IS AVAILABLE IN TB 43-0213, CORROSION PREVENTION AND CONTROL (CPAC) FOR ARMY WHEELED VEHICLES (SEP 12), AVAILABLE FROM LOGSA AT: <https://liw.logsa.army.mil/etmapp/#/etm/home>

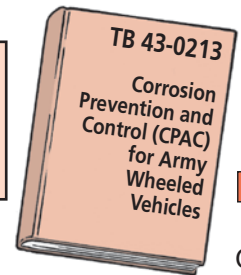

Common Primers and Paints

THESE CHARTS PROVIDE NSNs FOR SOME OF THE MORE COMMON PRIMERS AND PAINTS THAT YOU'LL NEED FOR SPOT PAINTING...



Primer	
Size	NSN 8010-
1.25 quarts	01-603-2126
250-ml spray, 6 cans	01-610-7329
400-ml spray, 6 cans	01-610-7330

Interior Epoxy Paint, 2-qt Kit	
Color	NSN 8010-
Gray	01-419-1152
Black	01-419-1142
White	01-414-8435

WD CARC Topcoat		
Color	Kit Size	NSN 8010-
Green	3 pints	01-493-3168
	3 quarts	01-493-3169
	3 gallons	01-493-3170
	15 gallons	01-493-3171
Brown	3 pints	01-493-3172
	3 quarts	01-493-3173
	3 gallons	01-493-3174
	15 gallons	01-493-3175
Tan	3 pints	01-493-3176
	3 quarts	01-493-3177
	3 gallons	01-493-3179
	15 gallons	01-493-3180
Black	3 pints	01-493-3182
	3 quarts	01-493-3183
	3 gallons	01-493-3190
	15 gallons	01-493-3191

Heat-Resistant Paint, 1-qt	
Color	NSN 8010-
Green	01-235-2693
Black	01-235-4165
Dark gray	01-608-4661

WD CARC Aerosol Spray			
Color	Size	Qty	NSN 8010-
Green	70 ml	12 cans	01-546-7712
	400 ml	6 cans	01-633-9119
Brown	70 ml	12 cans	01-546-7709
	400 ml	6 cans	01-652-4917
Black	70 ml	12 cans	01-546-7713
	400 ml	6 cans	01-633-9122
Tan	70 ml	12 cans	01-546-7711
	400 ml	6 cans	01-633-9116

WD CARC Roller Applicator, 2.37-oz Bottle		
Color	Qty	NSN 8010-
Green	12 bottles	01-546-7593
Black	12 bottles	01-546-7596
Brown	12 bottles	01-546-7595
Tan	12 bottles	01-546-7594

WD CARC Brush Applicator, 2.37-oz Bottle		
Color	Qty	NSN 8010-
Green	12 bottles	01-546-7585
Black	12 bottles	01-546-7589
Brown	12 bottles	01-546-7588
Tan	12 bottles	01-546-7587



BEWARE TIRE SHINE



SURE, YOU WANT YOUR RIDE TO SPARKLE, EVEN IF IT'S A DRAB ARMY GREEN OR TAN TACTICAL VEHICLE. BUT USING TIRE SHINE PRODUCTS TO GET THAT SPARKLE *ISN'T* AUTHORIZED.

THAT'S BECAUSE **TIRE SHINE TOTALLY CONTRADICTS CAMOUFLAGE.**

WHAT GOOD IS A VEHICLE'S CAMOUFLAGED PAINT SCHEME IF REFLECTIONS FROM THE SHINY TIRES CAN BE SEEN MILES AWAY?

EVEN WORSE, TIRE SHINE PRODUCTS **DON'T PROTECT** TIRES AND MAY EVEN **DEGRADE** RUBBER. CERTAIN TIRE SHINE PRODUCTS CONTAIN PETROCHEMICALS AND SILICONES THAT CAN BREAK DOWN THE RUBBER AND THE PROTECTIVE SUBSTANCES IN THE TIRES.

THESE PRODUCTS ARE LIKE THE GRIM REAPER TO TIRES!

Never use tire shine



Tips to Protect Tires

Ditch the tire shine and follow these tips to protect tires:

1. Always keep tires properly inflated.
2. Drive vehicles regularly to "exercise" the tires, which helps prevent cracking due to aging.
3. To wash tires, use only mild soap and water with a soft bristle brush or cloth.
4. Never use chemical cleaners, especially anything petroleum-based, because they strip protective substances from tires and contribute to cracking.
5. Limit the use of pressure washers and avoid steam cleaners; they can also damage tires.

Proper tire inflation helps prevent aging



Wash with brush or cloth and soapy water, never harsh chemicals



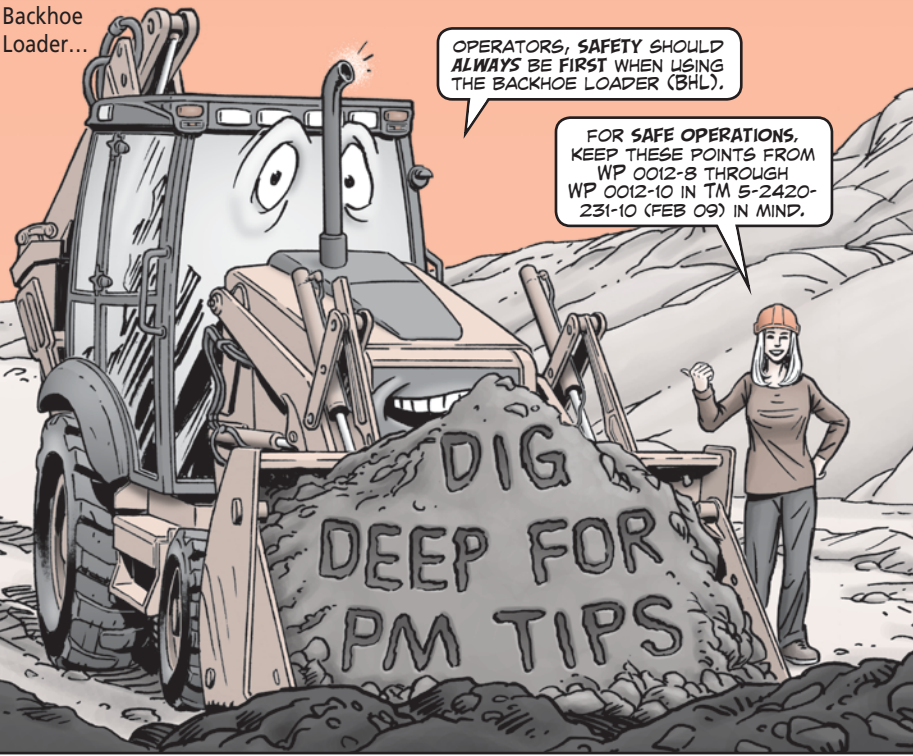

OPERATORS, SAFETY SHOULD ALWAYS BE FIRST WHEN USING THE BACKHOE LOADER (BHL).

FOR SAFE OPERATIONS, KEEP THESE POINTS FROM WP 0012-8 THROUGH WP 0012-10 IN TM 5-2420-231-10 (FEB 09) IN MIND.

Let's Do Some Digging

WHEN OPERATING THE LOADER ON A HILL, USE THE STABILIZERS TO LEVEL THE VEHICLE.

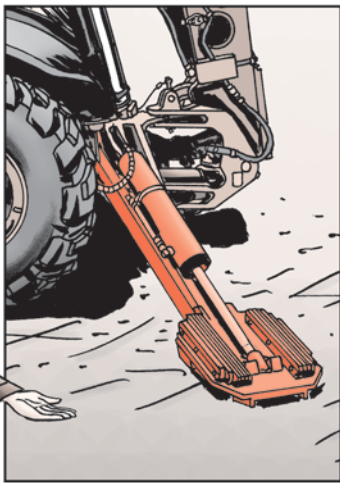

- Put dirt from the trench on the highest side of the trench.
- *Don't* use the bucket to move the BHL on a side slope.
- Operate with the seat in the loader position and the seat belt fastened.
- Always engage the parking brake and move the shift-direction control lever to neutral before operating the backhoe.

Drawing the Line

A GOOD RULE OF THUMB IS TO EXTEND THE BACKHOE BOOM AND DRAW AN ARC IN THE DIRT BEFORE YOU START DIGGING. THIS ARC LINE FORMS A HALF-CIRCLE THAT'S ALMOST 18 FEET FROM THE BACK OF THE VEHICLE.

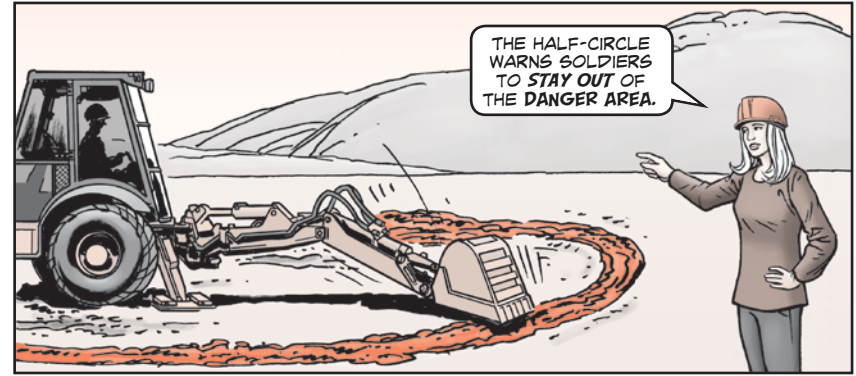

THE HALF-CIRCLE WARNS SOLDIERS TO STAY OUT OF THE DANGER AREA.

Backfilling Trenches

DON'T BACKFILL A TRENCH WITH THE BACKHOE BY SWINGING ITS BUCKET AGAINST THE SOIL.

Backhoe is used for scooping up dirt only



USING THE BUCKET TO PUSH DIRT CAUSES UNNECESSARY WEAR-AND-TEAR ON THE BUCKET AND BOOM.

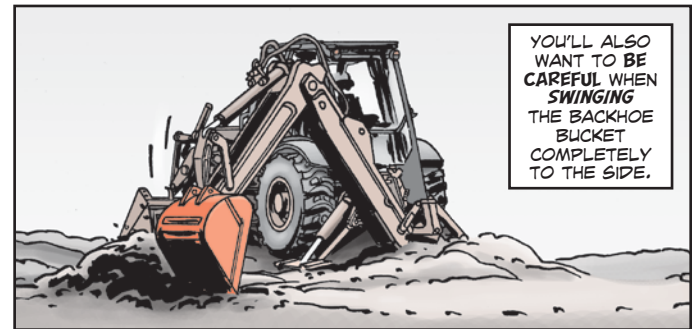

YOU'LL ALSO WANT TO BE CAREFUL WHEN SWINGING THE BACKHOE BUCKET COMPLETELY TO THE SIDE.

IN SOME POSITIONS, THE BACKHOE CAN ACTUALLY BUMP INTO THE VEHICLE'S STABILIZERS, DAMAGING THE STABILIZER'S HYDRAULIC CYLINDERS.

BE ALERT FOR TURBO BURNOUT!

LET'S GET
GOING!
WE'VE GOT A
LOTTA DIRT
TO DIG!

WAIT A MINUTE!
YOU'D BETTER PRIME MY
TURBO-CHARGER FIRST.
I'VE BEEN SITTING HERE
FOR QUITE A WHILE.

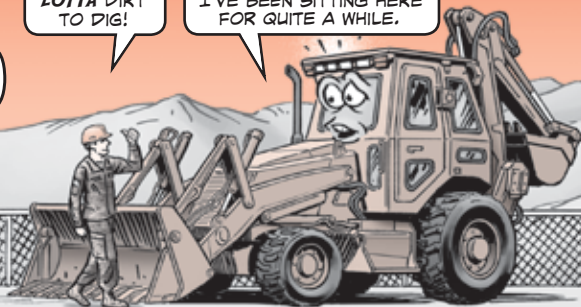

OPERATORS,
REMEMBER TO
PRIME YOUR
BACKHOE LOADER
(BHL) **BEFORE** START
UP, ESPECIALLY IF
THE VEHICLE HAS
BEEN SITTING FOR
SEVERAL WEEKS.



PLAIN AND SIMPLE,
THE IMPELLER
INSIDE THE ENGINE'S
TURBOCHARGER **NEEDS**
LUBRICATION WHEN
IT FIRST STARTS UP.
YOU'LL FIND THIS
CAUTION SPREAD
THROUGHOUT
TM 5-2420-231-10
(FEB 09).

CAUTION

If the BHL has *not* been operated for several weeks or engine oil filter has been replaced, prime turbocharger with oil per priming turbocharger procedure below. Failure to comply may result in *damage* to the turbocharger.



WHEN OIL **DON'T**
GET PUMPED INTO
THE IMPELLER'S
BEARINGS, THEY
CAN BURN UP.

THEN YOU'RE
STUCK WHILE YOUR
LOADER GOES
TO SUSTAINMENT
MAINTENANCE TO
REPLACE A RUINED
TURBOCHARGER.

SO MAKE SURE
YOU PRIME MY
TURBOCHARGER
FOLLOWING THE
PROCEDURE IN
WP 0010-3.

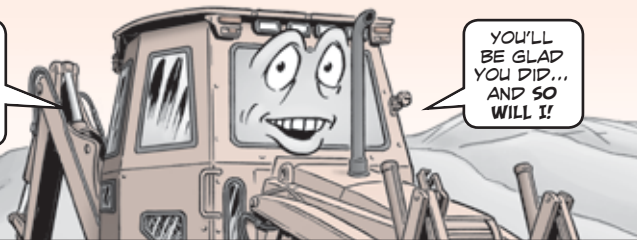

YOU'LL
BE GLAD
YOU DID...
AND SO
WILL I!

BUSHINGS BUSHED?

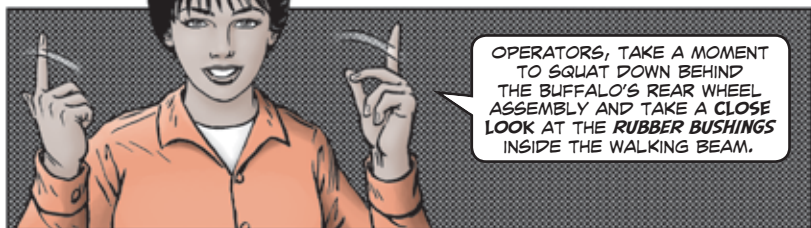

Over time, the rubber bushings wear out from exposure to the elements, normal wear-and-tear and vehicle vibration. When that happens, the back end of the vehicle starts to sway and it feels like there's some play in the suspension.

If you see rust stains around the rubber bushings, or if the bushings look cracked, worn or dry-rotted, tell your mechanic. He'll get 'em replaced.

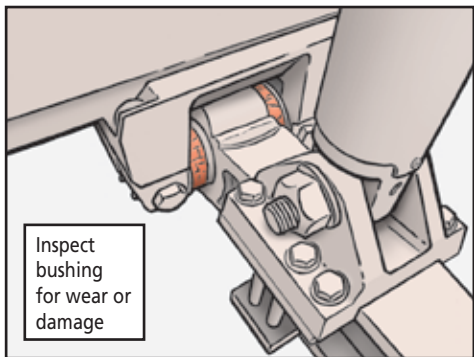

You'll find the bushing check highlighted as Item 78 and 100 in the PMCS charts on WPs 0110-60-61 and 0174-75 in TM 9-2355-352-10 (Sep 17).

Engine Upgrade a Dead End?

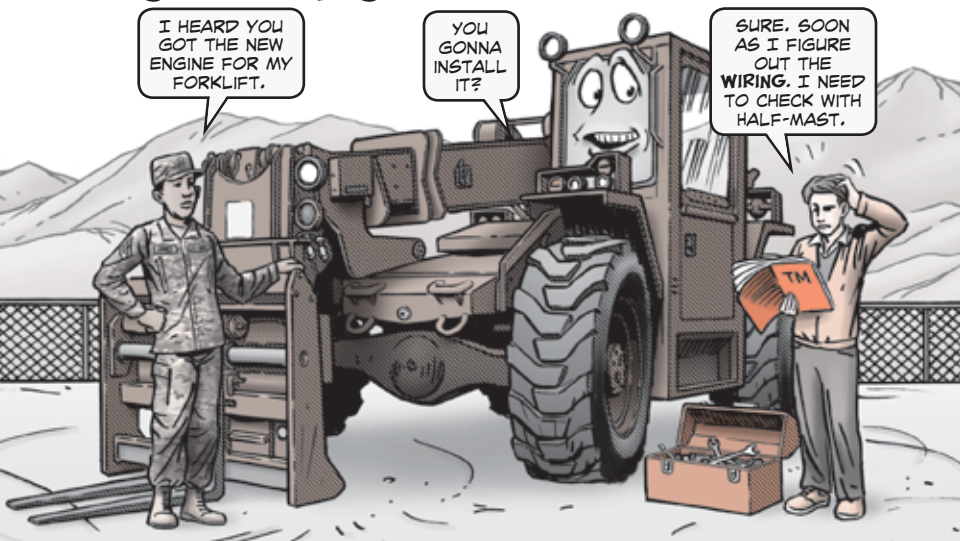

Dear Half-Mast,

We have a 6K variable reach rough terrain (VRRT) forklift with a blown engine in our Logistics Readiness Center shop.

The forklift's old **152-hp engine**, NSN 2815-01-293-7121, is no longer available. It was replaced by NSN 2815-01-443-1309. This is the same 165-hp engine that's used in the ATLAS forklift except for a few differences in the wiring schematic.

While everything fits in place, we're having problems with the vehicle's wiring. It doesn't match and the fuel shut-off on the new engine is different.

The TM has most of the parts, except for the wiring harness, to complete the upgrade. Is there an MWO that will assist with the forklift's engine upgrade?

Mr. L.S.P.



ELSE...

Ordering IHADSS Visor Assembly



HEY, VAUGHN!
CAN YOU GET
ME THAT
**VISOR HOUSING
DISPLAY** FOR
MY HELMET?

VISOR HOUSING DISPLAYS
AREN'T AVAILABLE ANYMORE,
CHIEF. I'LL HAVE TO ORDER
THE NEXT HIGHER ASSEMBLY.

ELSE TECHS, THE **VISOR HOUSING DISPLAY**,
NSN 8415-01-471-0057 (PN 10114888-
101), FOR THE INTEGRATED HELMET AND
DISPLAY SIGHT SYSTEM (IHADSS) IS
NO LONGER AVAILABLE BECAUSE THE
SMR CODE IS XAOZZ.

YOU'LL NEED TO ORDER THE NEXT
HIGHER ASSEMBLY: **COVER VISOR,
INTEGRATED**, NSN 1270-01-464-
4838 (PN 10114887-101). IT **DOESN'T**
COME WITH THE CLEAR OR TINTED
VISORS, SO YOU'LL NEED TO
ORDER THEM **SEPARATELY**.

Visor housing display no longer available...

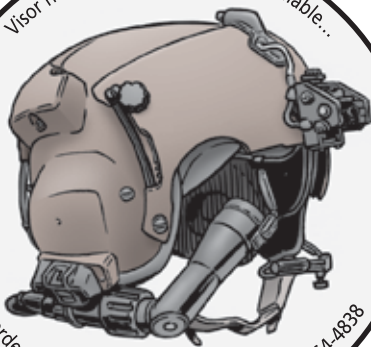

...order next higher assembly, NSN 1270-01-464-4838



LET YOUR ELSE
TECH KNOW IF
YOU NEED THE
CLEAR OR TINTED
VISORS FOR
YOUR HELMET.

NSN 1270-01-193-4986
(PN 10077101-102) BRINGS THE
VISOR AND SPRING ASSEMBLY
(TINTED VISOR).

NSN 1270-01-191-0993
(PN 10077101-101) GETS THE
VISOR AND SPRING ASSEMBLY
(CLEAR VISOR).

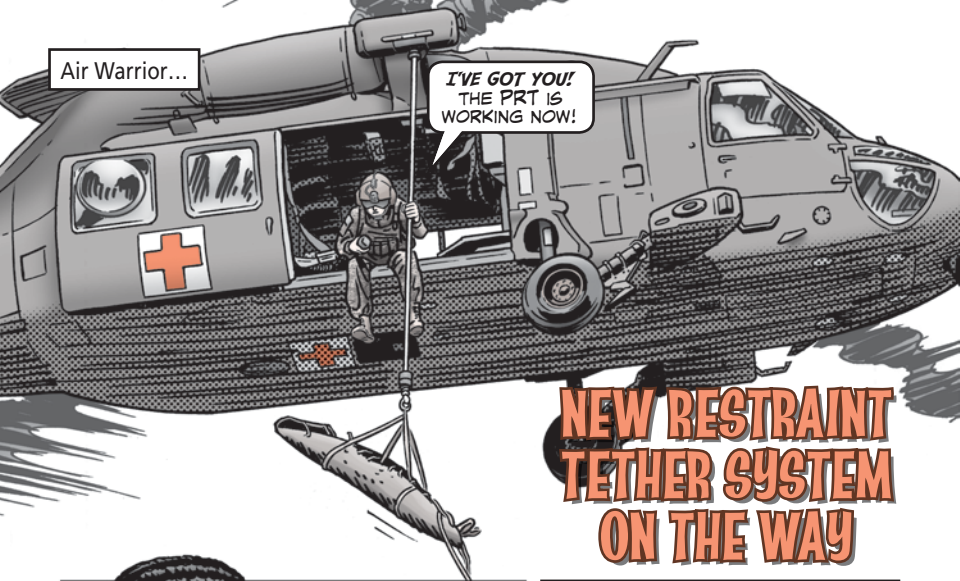

Air Warrior...

I'VE GOT YOU!
THE PRT IS WORKING NOW!

NEW RESTRAINT TETHER SYSTEM ON THE WAY



BLACK HAWK, LAKOTA, CHINOOK AND MEDEVAC CREWS: HAVE YOU HAD PROBLEMS WITH THE PERSONAL RESTRAINT TETHER (PRT) INADVERTENTLY DETACHING?

IF SO, IT'S CAUSED BY THE DESIGN OF THE PARACHUTE HARNESS QUICK EJECTOR SNAP. IT ALLOWS FOR DYNAMIC ROLLOUT UNDER CERTAIN CONDITIONS—NEVER A GOOD THING DURING HOISTING OPERATIONS.

PM AIR WARRIOR SOLVED THIS PROBLEM AFTER TESTING VARIOUS PROTOTYPES OF NEW TETHER SYSTEMS.

BE ON THE LOOKOUT FOR THE NEW CREW RESTRAINT ASSEMBLY (CRA).

THE CRA WAS ADAPTED FROM AN EXISTING NAVY RESTRAINT SYSTEM. IT CONSISTS OF A NEW QUICK-RELEASE EXTENSION TETHER (QRET) THAT ATTACHES TO THE CREWMEMBER'S SURVIVAL VEST AND A MODIFICATION TO THE CURRENTLY FIELDED PRT THAT ATTACHES TO THE AIRCRAFT ANCHOR POINT.

THE NEW PRT HAS A PARACHUTE D-RING IN PLACE OF THE QUICK EJECTOR SNAP. THE QRET INVOLVED A COMPLETE REDESIGN OF THE CURRENT TETHER.

TESTING INCLUDED LOADS OF FEEDBACK TO IMPROVE THE RESTRAINT SYSTEM. ONE EXAMPLE IS THE ADDITION OF D-RING ON THE QRET. IT PROVIDES AN ADDITIONAL FRONT CONNECTION FOR CREW HOIST OPERATIONS. THAT PROVIDES AN EXTRA LAYER OF PROTECTION THROUGH VISUAL CONFIRMATION OF TETHER ATTACHMENT DURING THE TRANSITION FROM AIRCRAFT TO HOIST HOOK ATTACHMENT.

- OTHER IMPROVEMENTS INCLUDE:**
- a cable system emergency quick release that's triggered using a pull handle attached to the front of the survival vest
 - an improved carabiner between the QRET and the PRT for multiple-use disconnects without using the emergency pull handle
 - handle cover to protect from inadvertent actuation by snag hazard or passenger

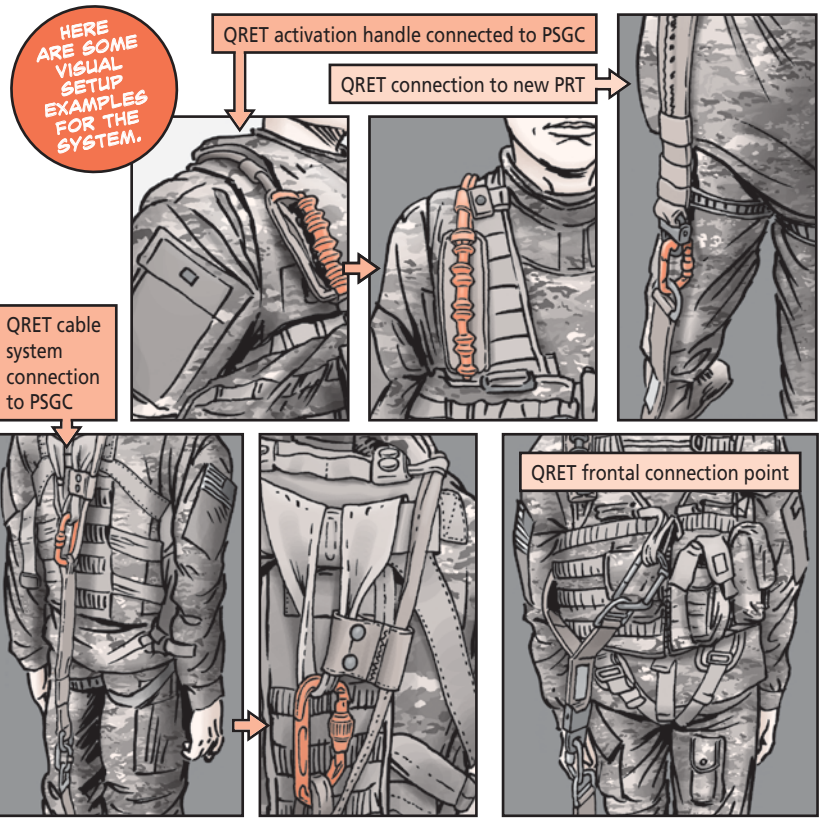

NOTE: HANDLE COVER NOT SHOWN IN ABOVE ILLUSTRATIONS.

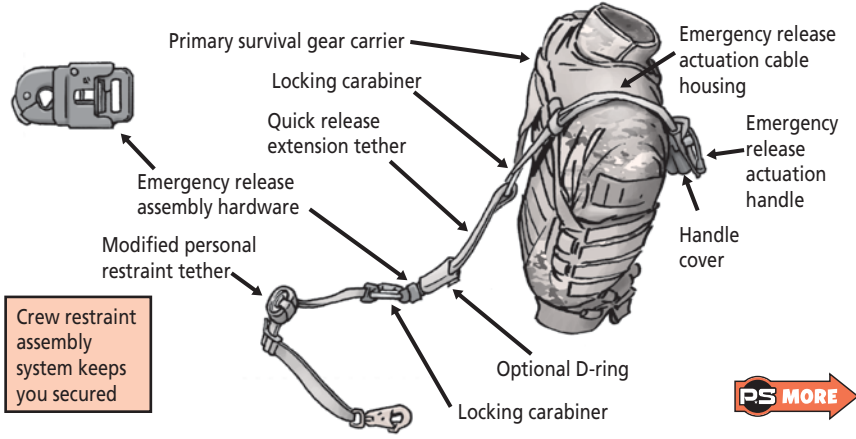

Use quick-release extension tether (PN 1050904-1) in crew restraint assembly

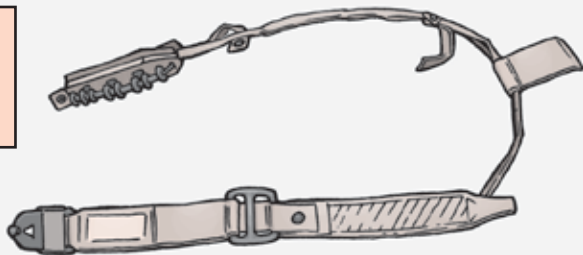

New PRT PN's are 1050903-1-1 (long) and 1050903-1-3 (short)



THIS NEW CREW RESTRAINT SYSTEM WILL BE FIELDED SOON TO PREVENT INADVERTENT DETACHMENT AND DYNAMIC ROLL OUT.

IT WILL BE FIELDED TO UNITS BASED ON PRIORITY AND SCHEDULES.

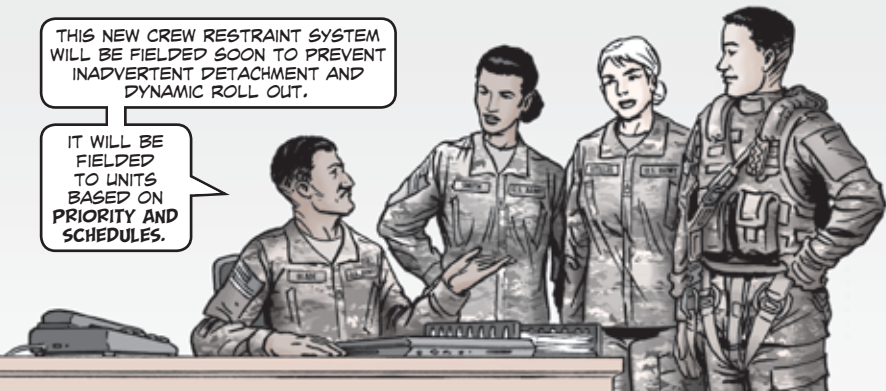

IN THE INTEREST OF SAFETY, **ALWAYS** REPORT **ALSO** EQUIPMENT ISSUES TO YOUR SUPERVISOR OR SAFETY OFFICER USING ESTABLISHED PROCEDURES.

AFTER ALL, **SAFETY STARTS WITH YOU.**



PS END

ECS Filter System Problems?

BOGIE I DON'T FEEL SO GOOD. I THINK I **INGESTED** SOME DEBRIS IN MY ECS SYSTEM.

YEAH, YOU'LL BE FEELING BETTER AS SOON AS YOU GET THE **NEW FILTER DUCT ASSEMBLY**.



MECHANICS, A RECENT ANALYSIS OF DAMAGED APACHE CREW-STATION ENVIRONMENTAL CONTROL SYSTEM (ECS) BLOWER FANS REVEALED **NEARLY HALF** WERE REPLACED BECAUSE OF FOREIGN OBJECT DAMAGE (FOD).

THE DAMAGE CAME FROM DEBRIS INGESTED THROUGH GAPS CREATED IN WARPED CREW-STATION ECS FAN DUCTS.

TO STOP FUTURE DAMAGE, AN IMPROVED FILTER DUCT ASSEMBLY WILL SOON **REPLACE** THE OLD CONFIGURATION.

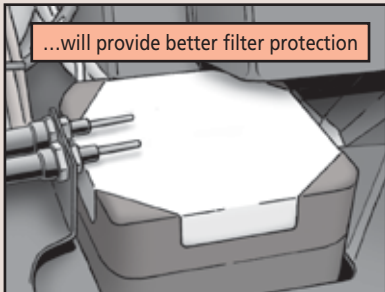
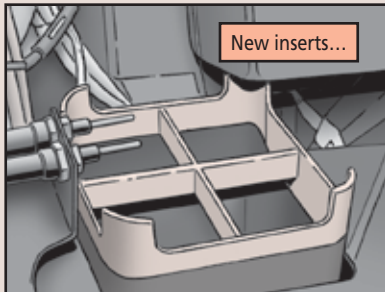

THE IMPROVED DESIGN IS **ALREADY** BEING INSTALLED ON NEW APACHES PRODUCED BY BOEING.

AN MWO WILL TAKE CARE OF THE REST OF THE AH-64 FLEET. THE **IMPROVED** FILTER DUCT ASSEMBLIES WILL BE AVAILABLE AS A **ONE-TIME FREE ISSUE** UNDER PN 7-61A21710-001 ONCE THE MWO IS APPROVED. REPLACEMENTS BEYOND THAT WILL HAVE TO BE ORDERED THROUGH THE SUPPLY SYSTEM.

MAKE A NOTE THAT THE CONFIGURATION CHANGE WILL BE REFLECTED IN A FUTURE UPDATE TO THE APACHE IETM.

QUESTIONS? CONTACT AMCOM'S BILLY CARROLL AT DSN 746-4577; (256) 876-4177 OR BY EMAIL: billy.w.carroll.ctr@mail.mil

MEDEVAC Needs Help With Litter Platforms

MY LITTER LIFT SYSTEM HAS THE **WRONG PINS!**

FOLKS, IF YOUR AIRCRAFT LITTER LIFT PLATFORMS HAVE THE WRONG PINS, YOU NEED TO GET THEM **TURNUED IN.**

READ BELOW FOR ALL THE DETAILS!



Mechanics, your MEDEVAC litter platforms play an important role in saving lives.

So it's important all units follow PD MEDEVAC's instructions to comply with ASAM H-60-ASAM-10 for the interim MEDEVAC mission support system (IMSS) hinge pins. You'll find the message at:

<https://asmprd.redstone.army.mil/default.aspx>

If you have unserviceable litter platforms, ship them to the headshed using FedEx shipping account number 491743964. Be very careful when packing the litter platforms so you don't cause any further damage. Ship them to:

Air Methods
6981 S. Quentin Street
Unit B
(Tom Williamson 303-749-2851)
Englewood, CO 80112

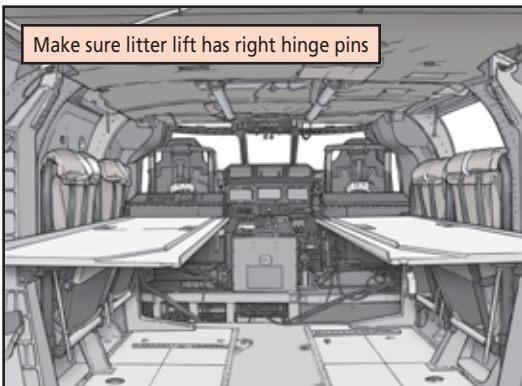

Got questions or need more information about the litter platforms? Contact Tracy Hicks at (256) 842-2103 or email: tracy.d.hicks.civ@mail.mil

presenting

JAMES BONDO in MOONBREAKER

(part I)

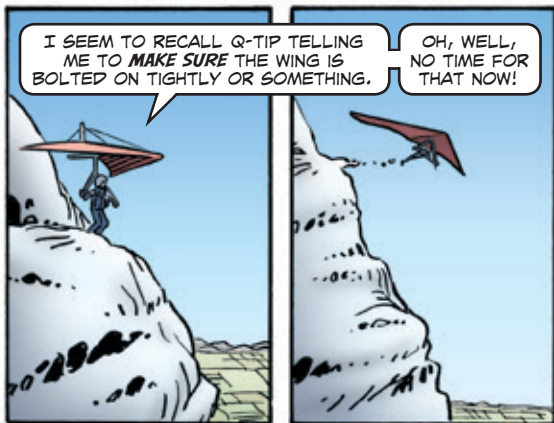
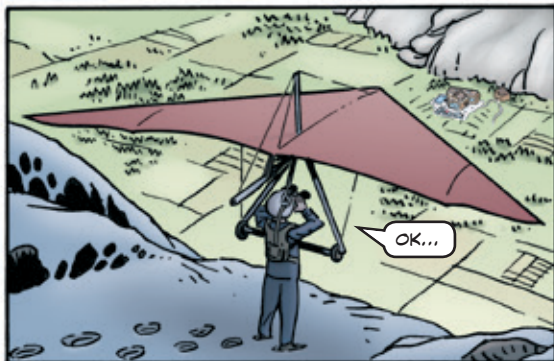

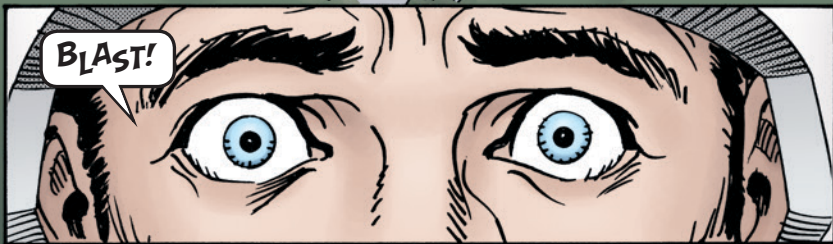
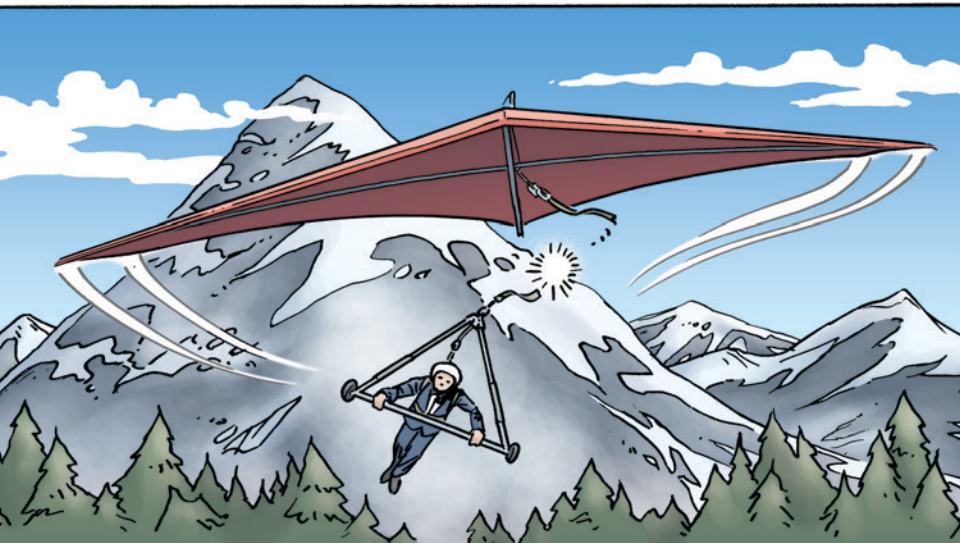

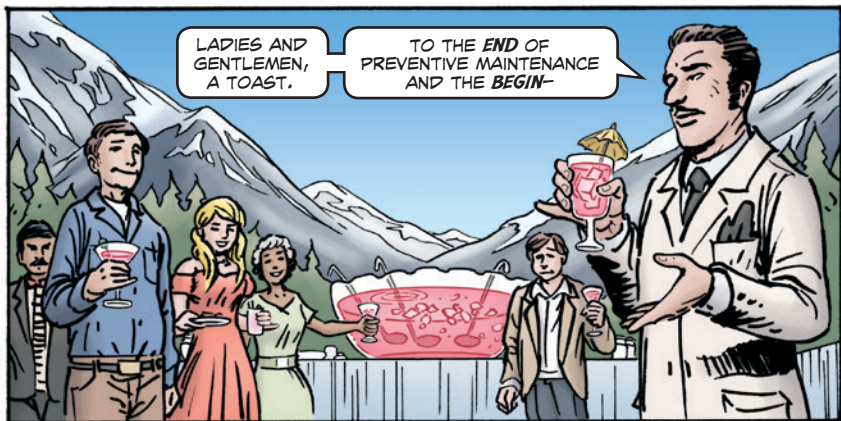

LADIES AND GENTLEMEN, A TOAST.

TO THE **END** OF PREVENTIVE MAINTENANCE AND THE **BEGIN-**



SPLASH



SO, BONDO, I SEE YOU'VE **NOT** DONE PREVENTIVE MAINTENANCE ON YOUR EQUIPMENT... AS USUAL.

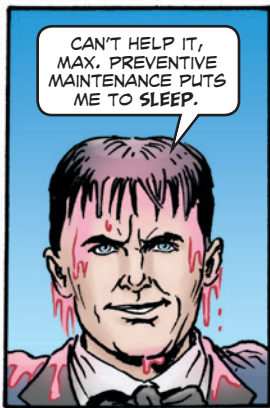

CAN'T HELP IT, MAX. PREVENTIVE MAINTENANCE PUTS ME TO SLEEP.

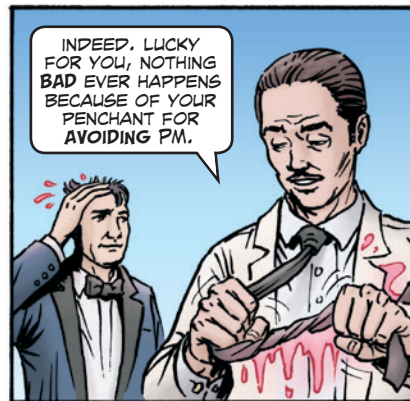

INDEED. LUCKY FOR YOU, NOTHING **BAD** EVER HAPPENS BECAUSE OF YOUR PENCHANT FOR AVOIDING PM.



DON'T BE DROLL, MAX.



NOW HAND OVER THAT COMPUTER DISK. THE ONE WITH YOUR PLANS FOR **SUBVERTING** WORLD-WIDE PREVENTIVE MAINTENANCE!



SO THAT'S WHY YOU 'CRASHED' MY LITTLE PARTY? WHY DIDN'T YOU JUST KNOCK ON MY FRONT DOOR LIKE A NORMAL PERSON AND SAVE US ALL THIS DRAMA?



WHAT CAN I SAY? I LIKE TO MAKE A SPLASH.

YES, I CAN SEE THAT.

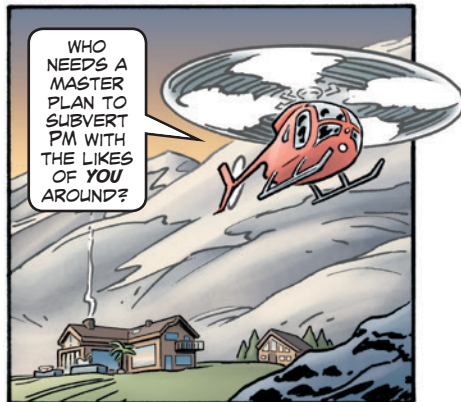
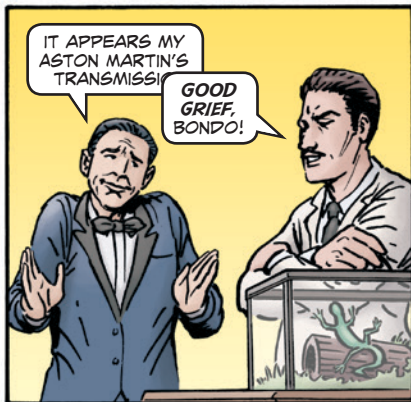
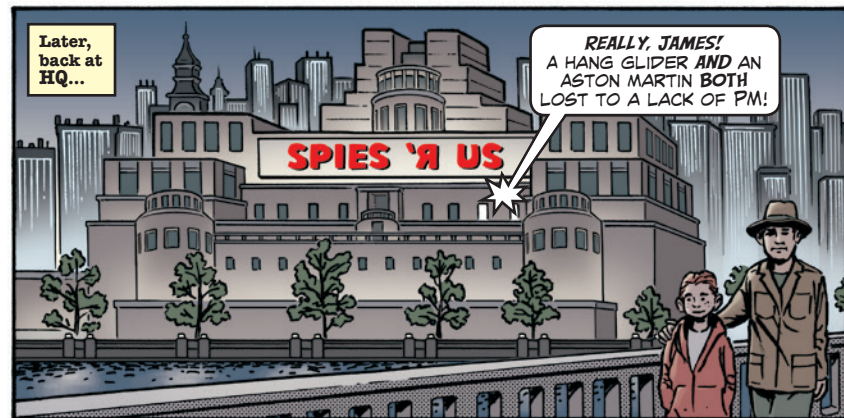



THERE ARE REPORTS COMING IN THAT AGENTS OF SHIM ARE UP TO THEIR OLD TRICKS AGAIN.



APPARENTLY THEY'VE *FINALLY* GOTTEN THEIR ANTI-PM RAY GUN OPERATIONAL AND THEY'RE PLANNING TO USE IT SOON!



STUPID HENCHMEN IGNORING MISCHIEF? IN MY LAST MOVIE, THEIR ANTI-PM RAY GUN WAS NOTHING MORE THAN A WORTHLESS HUNK OF *JUNK!*

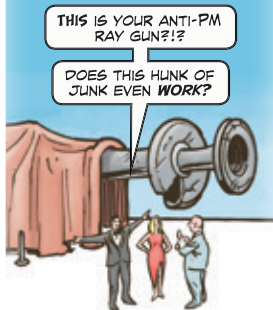

THIS IS YOUR ANTI-PM RAY GUN?!

DOES THIS HUNK OF JUNK EVEN *WORK?*



WELL, ACCORDING TO THIS, IT'S WORKING *NOW* AND THEY'VE HIDDEN IT ABOARD A *SPACE STATION* IN *LOW ORBIT.*



BONDO, AGAINST MY BETTER JUDGMENT, I'M SENDING YOU TO TAKE ON SHIM!

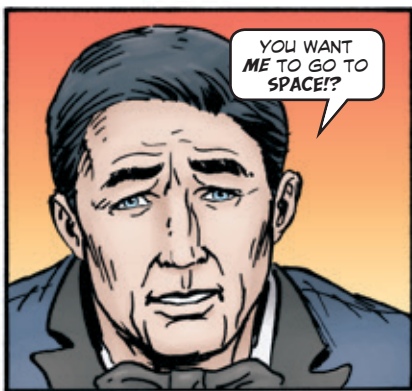

YOU WANT *ME* TO GO TO *SPACE!*?

Come back next month for the exciting conclusion of

MOONBREAKER

Strike Out NBCRV Stryker Problems!

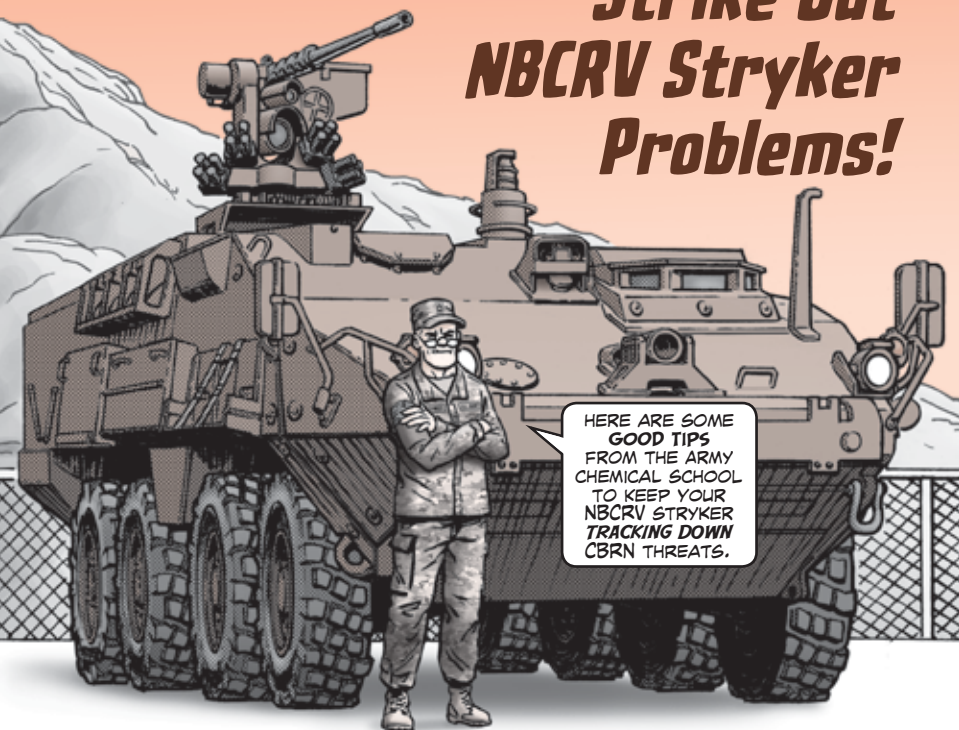

HERE ARE SOME
GOOD TIPS
FROM THE ARMY
CHEMICAL SCHOOL
TO KEEP YOUR
NBCRV STRYKER
TRACKING DOWN
CBRN THREATS.

Dear Editor,

Here are a few ways M1135 NBCRV Stryker crews can strike out detecting problems:

- **Run the chemical biological mass spectrometer (CBMS) on standby at least four hours per week.** Turn it on as soon as you start Monday PMCS. If you don't run the CBMS, it takes much longer for the sensor to come online. **But first open the probe post cover.** If the cover's closed, the probe gets very hot and the trapped heat causes damage. It's a good idea to put a sticker on the CBMS reminding crews to open the cover.

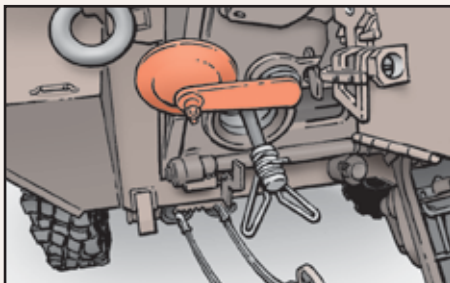

Run CBMS at least four hours weekly,
but remember to open probe post cover first

- Don't use the top of the sample introduction module (SIM) for storage. That can cause the CBMS exhaust hose to disconnect or kink. Exhaust has no way to get out of the vehicle.

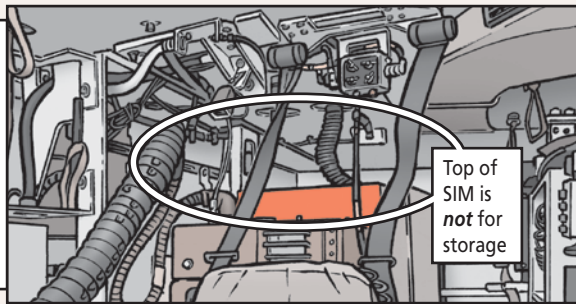

- Divide PMCS into two days. And use four people. There is so much to check that it's better to spend one day just checking out the Stryker and the next checking the NBC suite. A good PMCS really requires four people who know what they're doing. It's also a good idea to download all 17 TMs to a laptop. That saves you the problem of dragging the paper TMs to the motor pool. Download them at: <https://liw.logsa.army.mil/etmapp/#/etm/home>

- The same goes for circuit breaker 19 for the CBMS. The CBMS must be in the power off mode before you pull 19.
- Keep feet off all door seals. If you repeatedly step on seals, eventually they no longer seal. Then you have overpressure problems.

SFC Jose Albino
SFC Dwayne Bautista
SSG Gabriel Gastelo
Stanley Kuskco
Ft Leonard Wood, MO

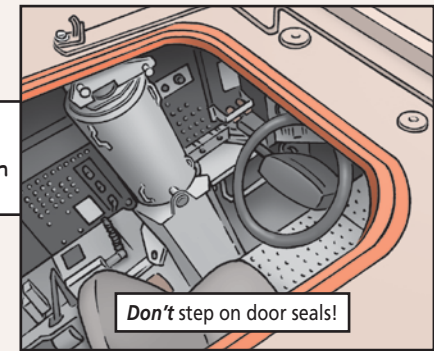

Editor's note: *These are strikingly good Stryker suggestions. Thanks for sharing.*

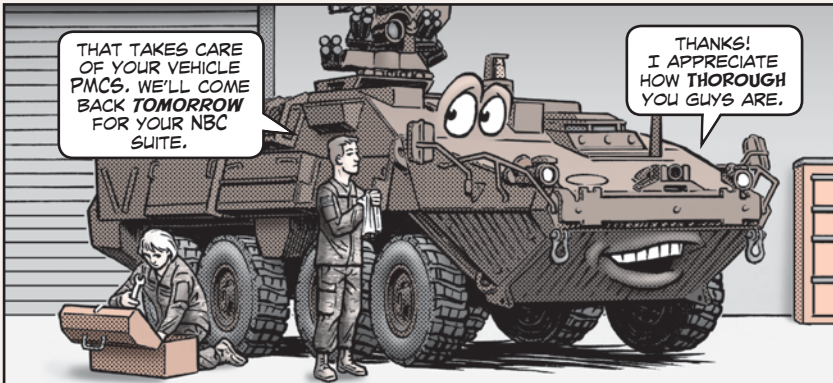

- Remember circuit breaker 3 on the suite power distribution panel (SPDP). After pushing in circuit breaker 3, you must turn on the operator display unit (ODU) within one minute or you'll get faults. At shutdown of the joint service lightweight standoff chemical agent detector (JSLSCAD), you must first put the system in STANDBY and then pull out circuit breaker 3 before shutting down the vehicle power. Otherwise, you'll get faults next time you operate.

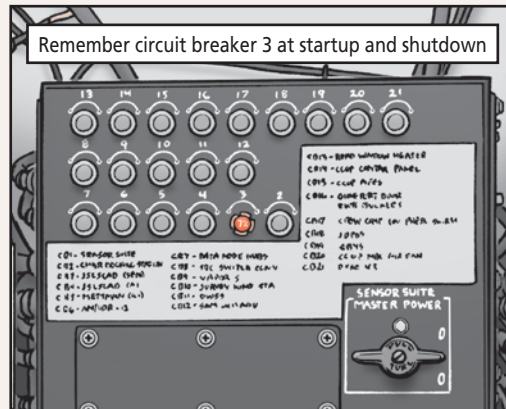

M26
Decon...

WATER PRESSURE GAUGE NEEDS CALIBRATION

BELIEVE IT OR NOT, MY WATER PRESSURE GAUGE **MUST** BE CALIBRATED OR I'M NMC!

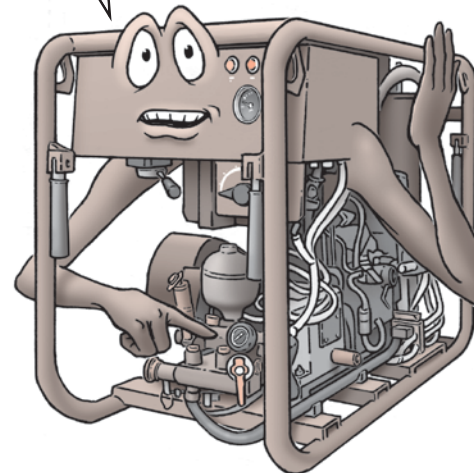

Dear Editor,
I noticed on WP 0008-2 of the M26 decon's TM 3-4230-238-23&P that the water pressure gauge is supposed to be calibrated every 1,080 days. The M26 is considered NMC if the gauge hasn't been calibrated or the TMDE calibration sticker is missing. I suspect most decon units aren't aware of this. Units need to have the water pressure gauge enrolled in the local TMDE program.

David Whitmire
JBLM, WA

Editor's note: *I suspect practically no decon units are aware of this. Thanks for pointing this out, David.*

A LOAD OF GOOD

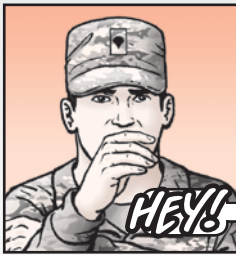

LOADING ADVICE

HEY!

DON'T EVEN THINK ABOUT THAT. I **ONLY** GO ON A PLS OR HEMTT-LHS!

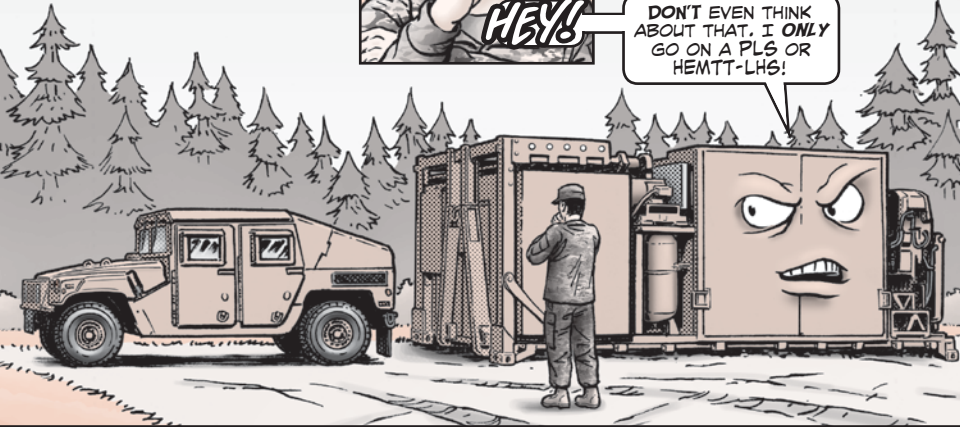

- When unloading the FRS, roll it as little as possible. Moving the FRS any way but backward or forward can take chunks out of its two rollers. If the rollers get too much damage, the FRS will be extremely hard to move. That could make the FRS NMC until the rollers are replaced. When you back up the truck for unloading, try to get as close as possible to the spot you're aiming at—within 10 feet is good.

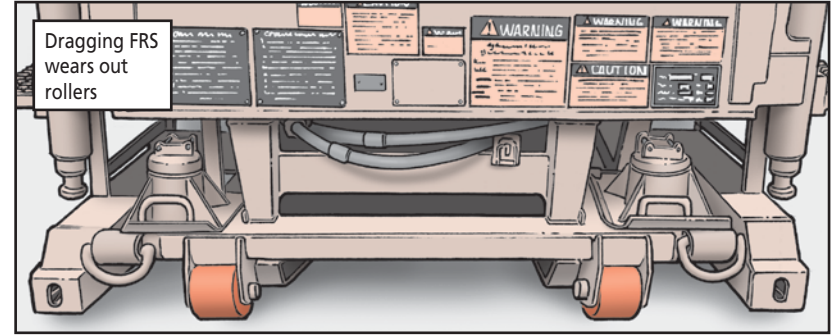

Dragging FRS wears out rollers

- Check the rollers during PMCS. They're usually ignored even though it's in the PMCS. If you see chunks missing or dry rot, tell your repairman. No use waiting to find out you've got bad rollers when you're ready to go to the field.

SSG Jason Firestine
SPC Detren Gregory
Ft Bragg, NC

Editor's note: Definitely a load of good advice. Thanks.

Dear Editor,

The principal reason the M7 Forward repair system (FRS) exists is to support units in the field. But to do that, it has to get to the field safely. Here are a few ways to help your FRS make the trip:

- Don't try to mount the FRS on anything but the PLS or the HEMTT-LHS. It won't work, so don't even try. It's the PLS, HEMTT-LHS or nothing.
- Slow and easy when hooking up the FRS...and use ground guides. The big danger is that the hook could swing out and crash right through the generator panel. Never pull the FRS at an angle as you may break the hook bar. Then you're facing a major repair or an expensive replacement.

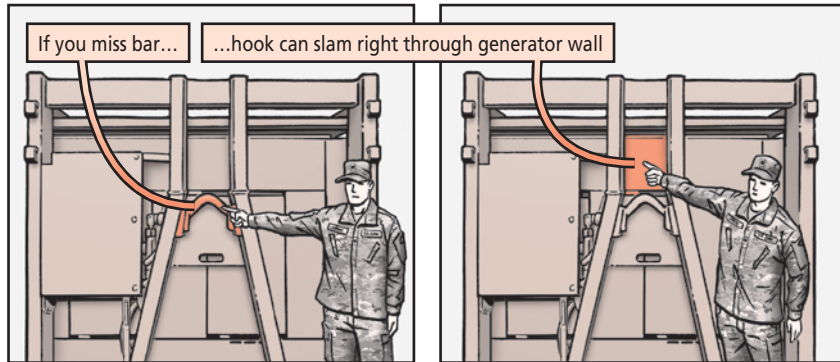

If you miss bar...

...hook can slam right through generator wall

FRS Door Latch?

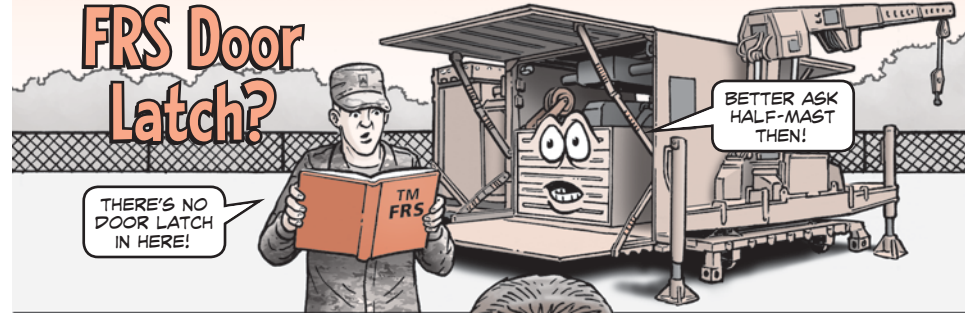

BETTER ASK HALF-MAST THEN!

THERE'S NO DOOR LATCH IN HERE!

Dear Half-Mast,
I have searched the M7 Forward repair system's TM 9-4940-568-24P for the rubber door latch NSN with no luck. Is there one?

SSG R.M.

YES, THERE IS, SERGEANT. ORDER THE DOOR LATCH WITH NSN 5340-01-560-8768.



The Best BST Tips

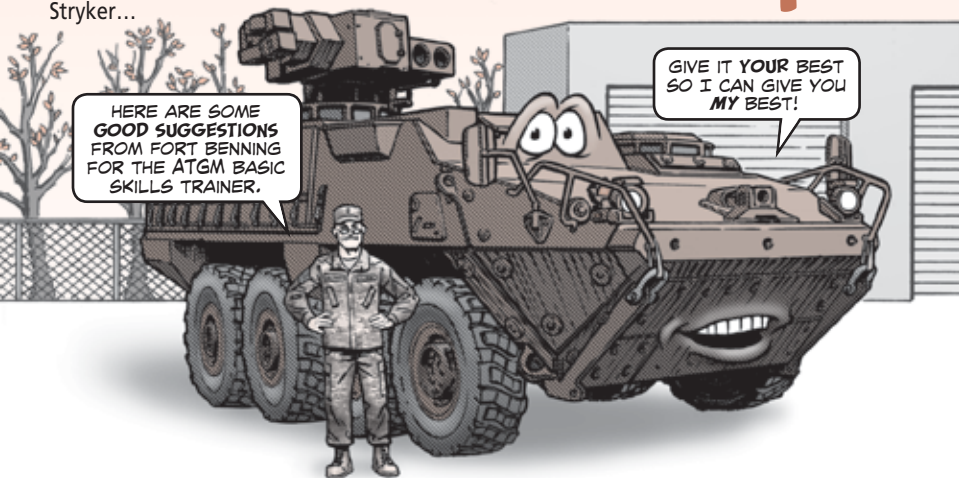

Dear Editor,

Here are a few tips for getting the best out of the basic skill trainer (BST) for the anti-tank guided missile system (ATGM) Stryker. We developed these at the Stryker Master Gunners Course.

First, make sure the cables are in good working order with no missing or broken pins. That saves trouble-shooting time.

Do the daily readiness checks. That not only checks out the BST but helps gunners train on what the various switches do.

When training is done, make sure the gunner panel assembly, gunner display assembly and hand controller cables are properly reconnected. Hand tighten the cables so that the red line isn't visible. If the cables aren't connected right, the ATGM malfunctions.

If the system does malfunction, turn off the vehicle MAIN and AUX power and re-check the three cables' connections.

SFC Stephen Brown
Ft Benning, GA

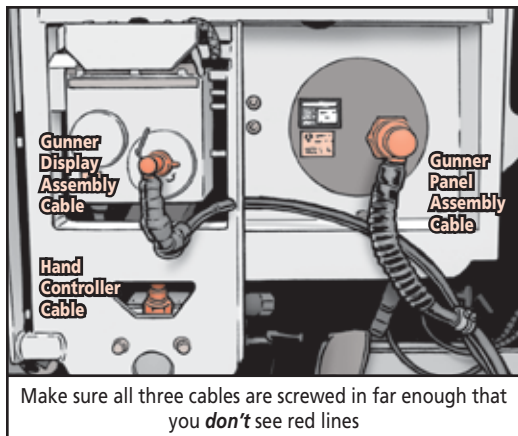

Editor's note: We agree these are the best BST tips. Thanks for sharing.

DON'T LET M240B GET EXHAUSTED!

WAIT A MINUTE! YOU GUYS WILL JUST BE FIRING ROCKETS TODAY, NOT ME.

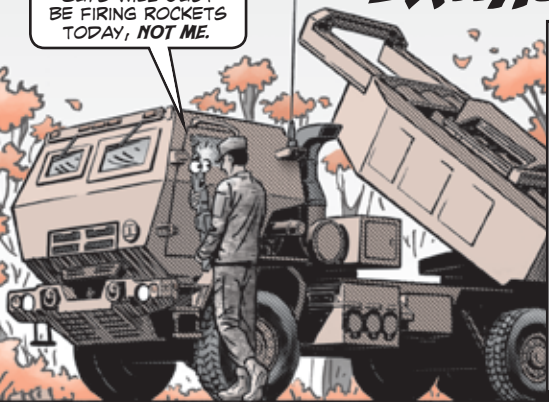

Dear Editor,

If you don't protect the M240B machine gun from the HIMARS' rocket exhaust, soon you'll need a new M240B. The exhaust can strip the finish right off the weapon. No finish means it has no protection against corrosion. If the receiver becomes too corroded, there's no choice but to junk the M240B.

The best way to protect the M240B is to put it in the cab before you fire. Make sure the weapon is cleared before you put it in the cab.

If the M240B is ever exposed to rocket exhaust, inspect it as soon as you return from the field. If the finish has been stripped off in spots, touch it up with solid film lubricant (SFL).

Examine M240B for shiny spots if exposed to rocket exhaust...



... and touch up with SFL

NSN 9150-01-260-2534 brings a 16-oz aerosol can of SFL. You can also get a 1-qt can with NSN 9150-01-360-1908 and a 1-gal can with NSN 9150-00-142-9361. These are non-aerosol and must be applied with a brush, which will produce a more even application than spraying SFL. Regardless of which kind you use, carefully follow the instructions on the can for best results.

The exhaust can *also* affect the barrel nut, making it difficult to remove the barrel. So check that too when you return from the field.

SGT Jeffrey Eirich
Ft Bragg, NC

Editor's note: You don't want rocket exhaust to finish off the M240B's finish. Thanks, Sergeant.

TARGET THESE TIPS FROM FT BRAGG'S LRC!

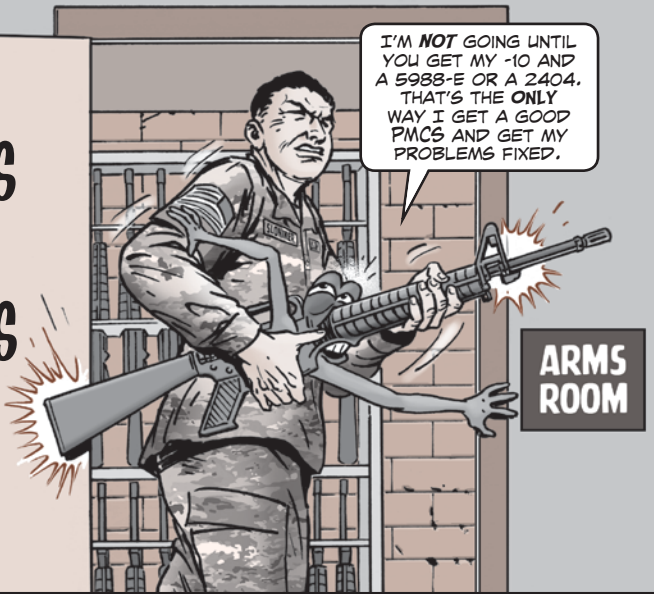

Dear Editor,

We see many weapons with problems here at the Logistics Readiness Center (LRC). Soldiers, armorers, and small arms repairmen can avoid many of those problems if they remember these points:

- **Don't let weapons leave the arms room without a -10 TM and a DA Form 5988-E or 2404 for each weapon.** Too often, the TMs never leave the arms room. That means Soldiers don't have the PMCS steps to make sure their weapons are in good shape or the troubleshooting procedures if their weapons fail in the field. Of course, some TMs won't make it back from the field. But they're free and your pubs clerk can order more. Weapons that work are worth the effort.

Those TMs also tell how to properly clean and lube weapons before they're turned in. Armorers should **never** accept any weapon that hasn't been cleaned or lubed. We see too many weapons that are so dirty they can't even be gaged.



- **No unauthorized mods!** Particularly with M16 rifles and M4 carbines, we are still seeing unauthorized modifications: grips, buttstocks, slings and flash suppressors, among other things. These mods aren't authorized because, in many cases, they not only don't help but actually hurt performance. A weapon that stops firing in a firefight is a Soldier's worst nightmare. If that isn't enough reason to stay away from these mods, remember that once a weapon gets to us, we remove these unauthorized parts and you never see them again.

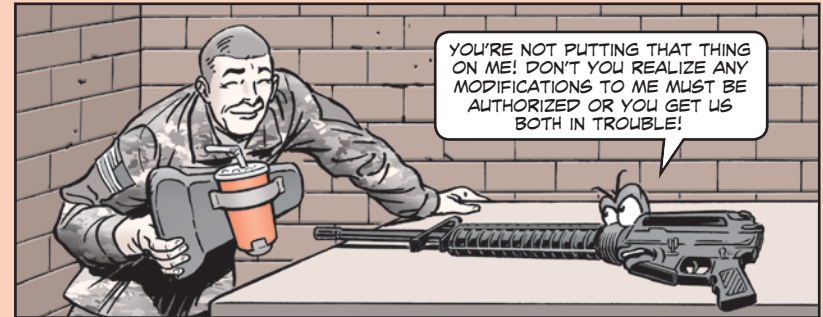

Eric Shove
Danual Smith
Ft Bragg, NC

THE **ONLY** TIME A WEAPON CAN BE MODIFIED IS IF THE ARMY HAS APPROVED A MODIFICATION WORK ORDER (MWO).

THIS IS SPELLED OUT IN AR 750-10, ARMY MODIFICATION PROGRAM (AUG 13).

SOLDIERS CAN BE HELD RESPONSIBLE FOR ANY DAMAGE RESULTING FROM UNAUTHORIZED MODS.

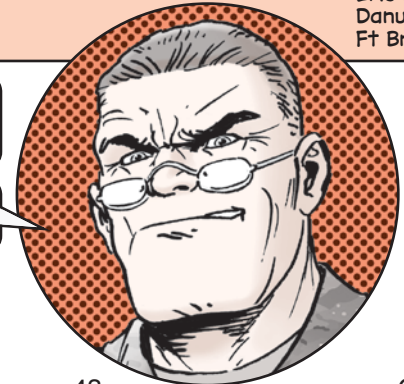

GET ADJUSTABLE BUTTSTOCK

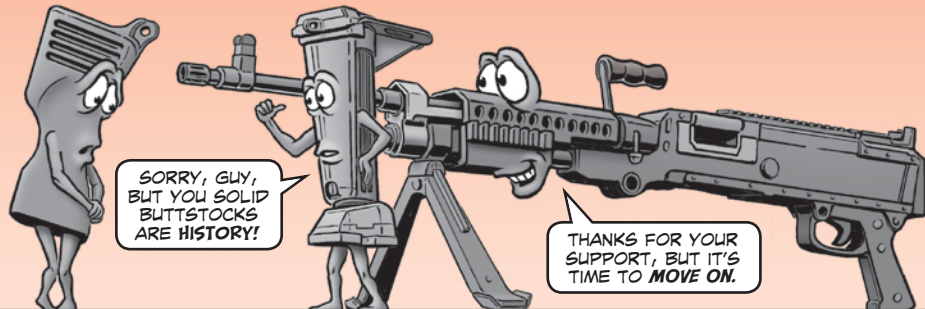

MWO 9-1005-313-23-1 MADE THE M240 SOLID BUTTSTOCK **OBSELETE**. IT'S BEEN REPLACED BY THE **ADJUSTABLE BUTTSTOCK**. NSN 1005-01-576-4661.

THE **ADJUSTABLE BUTTSTOCK** CAN BE USED ON ALL M240 MODELS, INCLUDING THE M240H EGRESS KIT.

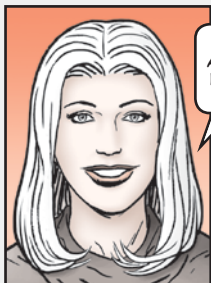

MAKE A NOTE OF THAT **ADJUSTABLE BUTTSTOCK NSN!** IT **HASN'T** YET BEEN ADDED TO TM 9-1005-313-23&P.

ADJUSTABLE BUTTSTOCK PARTS INFO CAN BE FOUND ON PAGES 36-39 IN PS 788 (JUL 18):

<https://www.logsa.army.mil/web2/archive/PS2018/788/788-36-39.pdf>



THERE ARE **NO** REPAIR PARTS AVAILABLE FOR THE **SOLID BUTTSTOCK**.

BUT IF YOUR SOLID BUTTSTOCK IS STILL IN GOOD SHAPE, KEEP USING IT UNTIL IT ISN'T.

THEN ORDER THE **ADJUSTABLE BUTTSTOCK**.

HOW TO INSTALL BARREL CORRECTLY

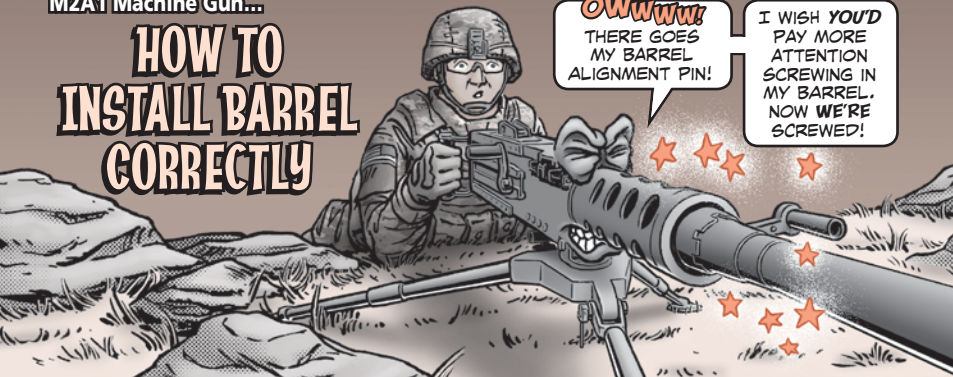

Dear Editor,

Please emphasize the importance of installing the M2A1 machine gun's barrel correctly. Too often Soldiers screw the barrel in and start firing. As a result, the barrel's alignment pin shears off and the whole barrel has to be replaced. We've had to replace 12 barrels in two months. At over \$800 a barrel, that runs into serious money.

Fred Fanning
Kevin Strange
Ft Leonard Wood, MO



1. Raise the cover assembly all the way up. Grasp the retracting side handle and pull it back slightly until you see the square on the barrel locking lug through the $\frac{3}{8}$ -in hole in the right side of the receiver.
2. Insert the barrel into the barrel support until the barrel alignment pin engages the alignment slot.
3. Rotate the barrel clockwise and secure the alignment pin in the alignment slot.
4. Make sure the barrel's chamber end protrudes beyond the barrel extension threads.
5. Release the retracting slide handle and allow the bolt to go forward.
6. Make sure the barrel threads are locked into the barrel extension.
7. Close the cover assembly. Charge the M2A1, making sure the barrel moves forward and backward during charging.

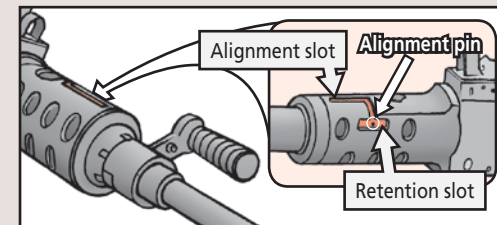
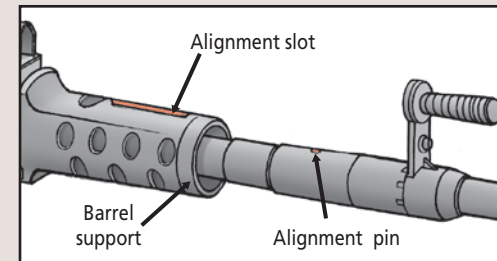
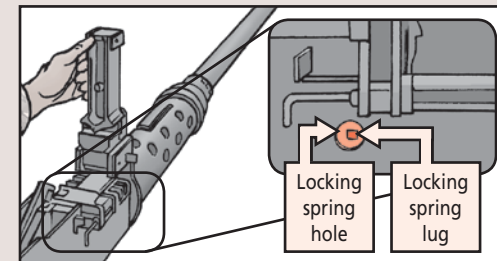

TAP INTO POWER GENERATION TRAINING!

SOLDIERS, WHAT'S THE STATUS OF YOUR P/E TRAINING? HERE'S A REMINDER WHY IT'S IMPORTANT TO BE UP-TO-DATE!

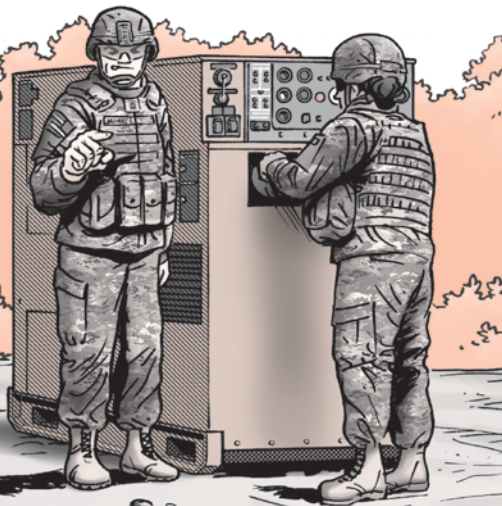

Dear Editor,

I work with the Communications-Electronics Command (CECOM) as a Power Generation and Environmental Systems LAR. We give technical and logistical support to ground support equipment maintainers and operators, both in garrison and during training at the combat training centers (CTCs).

I want to remind your readers about the importance of making sure operators are properly licensed on all electrical power generating equipment from 0.5-kW and above, including commercial model power generation equipment like HDT (Formerly DRASH) trailer-mounted support systems.

This requirement is covered in Section 1, Chapter 7 of AR 600-55, *The Army Driver and Operator Standardization Program (Selection, Training, Testing, and Licensing)* (May 17).

Too often we see environmental accidents, damage to costly electronics equipment and injuries when Soldiers aren't properly licensed and trained in operating tactical power generation equipment.

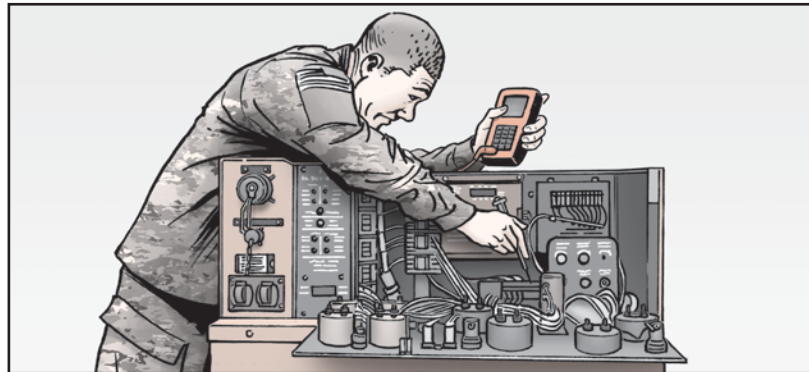

Just as with wheeled and tracked vehicles, commanders must ensure that their Soldiers are properly licensed on any equipment that their units are expected to use during their CTC rotation.

Commanders and master driver trainers (MDTs) need to know the licensed requirements for power generation equipment in accordance with AR 600-55. This training must be annotated on the operator's DA Form 348, *Equipment Operator's Qualification Record (Except Aircraft)*.

Operator training can be provided by any qualified 91 Delta (tactical power generation specialist) or the NCOs assigned as MDTs.

CECOM P/E LARs can also provide operator and sustainment maintenance training to the 91 Deltas.

Sammy Harden
Kaiserslautern, Germany



Editor's note: *Thanks for a powerful reminder, Sir! Soldiers, is your P/E training up-to-date?*

STT TM Released

TM 11-5895-1868-13&P (JAN 18) IS A NEW MANUAL COVERING THESE SATELLITE TRANSPORTABLE TERMINAL (STT) MODELS:

- AN/TSC-185(V)1, NSN 5895-01-563-9077
- AN/TSC-185A(V)1, NSN 5895-01-608-7431
- AN/TSC-185B(V)1, NSN 5895-01-646-3037
- AN/TSC-185B(V)2, NSN 5895-01-563-9056
- AN/TSC-185A(V)2, NSN 5895-01-608-6905
- AN/TSC-185B(V)2, NSN 5895-01-645-9460



DISTRIBUTION IS RESTRICTED, SO YOU'LL NEED TO LOG IN WITH YOUR CAC TO THE LOGISTICS INFORMATION WAREHOUSE AT:
<https://liw.logsa.army.mil/>

CHOOSE THE "ETM/IETM" ICON AND SEARCH FOR THE TM.

Check Your PAAWNS

TM 11-5895-1981-13&P (Dec 17) is available for the protected anti-scintillation/anti-jam wideband net-centric system (PAAWNS) modem group, satellite communications OM-88A(V)1/G, NSN 5895-01-618-3220. Distribution is restricted, so you'll need to log in to the Logistics Information Warehouse with your CAC at: <https://liw.logsa.army.mil/> Then choose the "ETM/IETM" icon and search for the TM.

Turn in Legacy Equipment

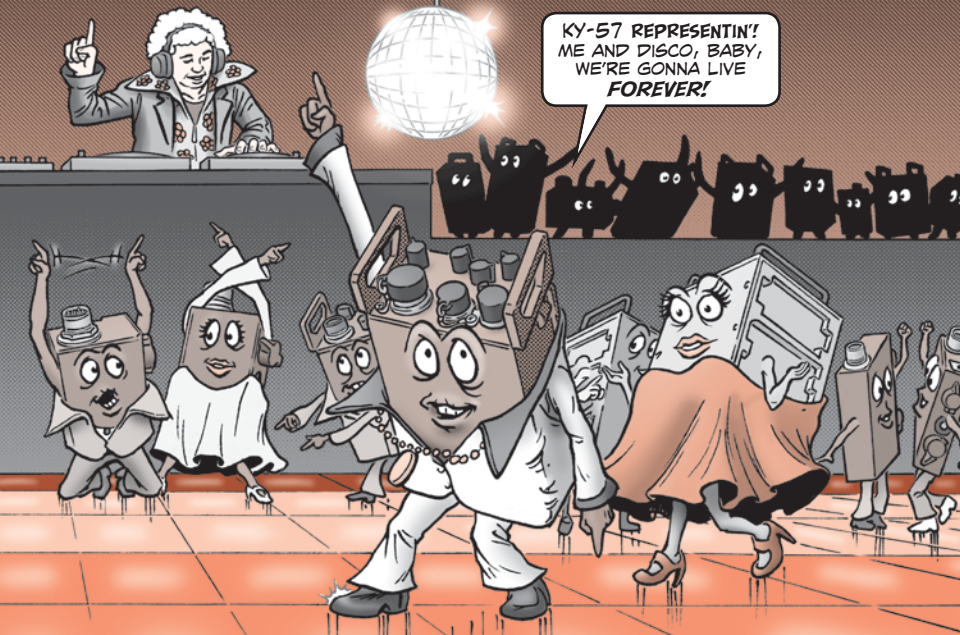

LEGACY IS A GREAT WORD. BUT WHEN USED FOR ARMY EQUIPMENT, THAT CAN ALSO MEAN IT'S OBSOLETE.

A WHOLE SLEW OF COMSEC EQUIPMENT HAS BEEN TAGGED AS OBSOLETE AND ISSUED ITS RETIREMENT PAPERS.

UNITS, CHECK THE FOLLOWING TABLES FOR DEVICES THAT THE ARMY IS RETIRING.

IT'S TIME FOR THESE TRUSTY OLD-TIMERS TO BOW OUT AND GET OFF THE BOOKS. MAKE ARRANGEMENTS TO TURN IN THESE LEGACY DEVICES BY THE END OF FY19, WITH THE FOLLOWING EXCEPTIONS:

- **KG-175A:** Extended through FY20.
- **KY-57, KY-58, KY-99, KY-100, KYV-5:** Extended through FY23.

Legacy Key Fill Devices

Nomenclature	NSN 5810-	LIN
AN/CYZ-10	01-343-1194	D78555
AN/CYZ-10A	01-312-6412	D78555
AN/CYZ-10v1	01-384-1996	D78555
AN/CYZ-10v2	01-388-7634	D78555
AN/CYZ-10v3	01-393-1973	D78555
KYK-13	01-026-9618	E98103
KIK-20	01-543-5943	FA1044
KOI-18	01-026-9620	T40405
KYX-15	01-026-9619	N02758
KYX-15A	01-095-1312	N02758

KYK-13

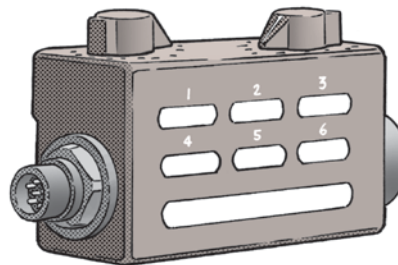

KG-84

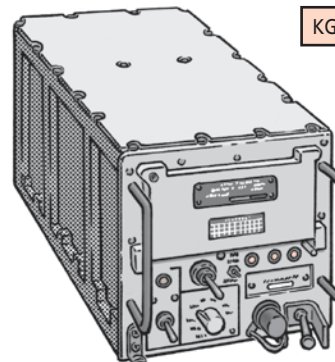

Legacy Link Encryption Family Devices

Nomenclature	NSN 5810-
KIV-19	01-449-7179
KIV-19A	01-492-5165
KG-194A	01-283-1394
KG-194	01-283-1395
KG-194 CCIT	01-317-6635
KG-194 EURCOM	01-319-2220
KG-84	01-118-7766
KG-84A	01-146-3260
KG-84C	01-250-6618
KG-94	01-187-9909
KG-94A	01-213-8200
KG-94A/194A IAU	01-280-4746
KIV-7	01-414-6656
KIV-7HS	01-431-8264
KIV-7HSA	01-430-4225
KIV-7HSB	01-487-6582
KG-95-1	01-263-8240
KG-95-2	01-263-8241
KG-95/2	01-335-8859
KG-95R	01-263-7291
KG-40A-P	01-351-3000
KG-40A-S	01-351-7226
KG-81	01-055-0048
KG-82	01-082-8403
KG-112	01-318-0640
KGR-68B	01-492-8450
KGV-68	01-231-6827
KGV-68B	01-414-7483
KGV-19M	01-548-8708



Legacy Secure Voice Devices

Nomenclature	NSN 5810-	Nomenclature	NSN 5810-
GD Edge CDMA	01-561-5848	KY-58 *	00-449-0154
GD Edge GSM	01-560-7462	KY-58-2	01-050-8115
L-3 Guardian GSM	01-580-3316	KY-58-3	01-050-9968
OMNI	01-515-8439	KY-58-4	01-050-8116
OMNixi	01-516-1231	KY-58-5	01-084-2200
Sectera BDI terminal	01-533-4833	KY-58-11	01-216-7795
Sectera GSM phone	01-495-1171	KY-99 *	01-307-5414
Sectera wireline	01-500-9264	KY-99A	01-391-0187
KY-100 *	01-376-1380	KYV-2A	01-160-4999
KY-57 *	00-434-3644	KYV-5 *	01-224-0202

* Turn in by end of FY23

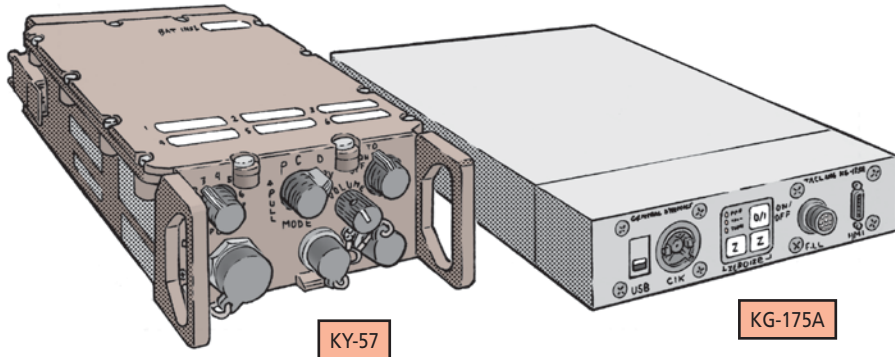

Legacy Inline Network Encryption Devices

Nomenclature	NSN 5810-	LIN	BOIP
KOV-26 (card only)	01-546-4543	Z01709	
KOV-26 (tactical kit)	01-558-5485	Z01709	
KOV-26 (office kit)	01-558-5539	Z01709	
KOV-26 (SOCOM kit)	01-558-3251	Z01709	
KOV-26 (Exec. kit)	01-580-4740	Z01709	
KG-83	01-111-4081	E03568	C016AC
KG-175 AC	01-463-0133	E08940	C231AA
KG-175 AC 1.2	01-473-3009	E08940	C231AA
KG-175 DC	01-463-0135	E08940	C231AA
KG-175 E100	01-486-1987	E08940	C231AA

Legacy Inline Network Encryption Devices (continued)

Nomenclature	NSN 5810-	LIN	BOIP
KG-175 E100 DC	01-532-1854	FA1003	
KG-175 R	01-554-7237	FA1003	
KG-235	01-497-5974	FA1003	C201AA
KG-75A FR3 OC 12	01-493-7873	FA1067	
KG-75A FR3 OC 48	01-515-4576	FA1067	
KG-75 OC3 FR2	01-451-8828	FA1092	
KG-175B	01-527-9296	FA1093	
KG-240	01-529-4257	FA1093	
KG-75 DS1 FR2	01-451-9236	FA1093	
KG-75 DS1 FR3	01-464-2769	FA1093	
KG-75 DS3 FR3	01-464-2770	FA1093	
KG-75 OC12 SS FR3	01-464-2775	FA1093	
KG-75 OC3 SM FR3	01-464-2768	FA1093	
KG-75 OC3 SS FR2	01-451-8826	FA1093	
KG-75A FR3 OC 3 SMSM	01-493-7871	FA1093	
KG-75A FR3 OC 3 MMMM	01-493-7872	FA1093	
KG-75A FR3 DS1	01-493-1638	FA1093	
KG-75A OC 3 ATM/SONET	01-582-2276	FA1093	
KG-75A FR3 DS3	01-493-1642	FA1093	
KG-189 OC 12 INR	01-426-3852	FA101G	
KG-189 OC 12 LINR	01-426-3857	FA101G	
KG-189 OC 12 LRNR	01-426-7610	FA101G	
KG-189 OC 3	01-406-9283	FA101G	
KG-189 OC 3 LRNR	01-426-3858	FA101G	
KG-189 OC12 IR	01-426-7619	FA101G	
KG-189 OC12 LIR	01-426-3854	FA101G	
KG-189 OC12 LRR	01-406-9284	FA101G	
SecNet 11	01-538-3078	FA107H	
KG-245	01-533-4928	FA107N	
KG-75 DS3	01-451-8827	Z39514	
KG-75 OC3 MM FR3	01-464-2771	Z39514	
IPS-250	01-590-7796	Z01806	
KG-175A *	01-527-9340	Z01704	
KIV-54 EM	01-577-9979	Z01762	
KIV-54 RM	01-542-8334	Z01763	

IF YOU HAVE QUESTIONS ABOUT LEGACY COMSEC DEVICES OR TURN-IN PROCEDURES, CONTACT DAVID TONEY AT (443) 395-2587; EMAIL: david.e.toney2.ctr@mail.mil

OR LISA OCASIO AT (443) 395-2360; EMAIL: lisa.m.ocasio.civ@mail.mil

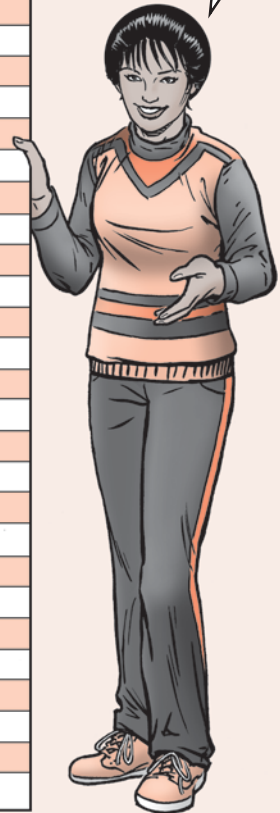

COOL TIPS FOR MTRCS



THE MULTI-TEMPERATURE REFRIGERATED CONTAINER SYSTEM (MTRCS) MAKES SURE FOOD GETS TO THE FIELD WITHOUT SPOILING.

DON'T SPOIL ITS WORK BY IGNORING THESE TIPS!

CHECK HOOK BEFORE HOOKUP

IF YOU DON'T CHECK THE POSITION OF THE HOOK ARM PIN ON THE M1074/A1 PLS OR M1120/A2/A4 HEMTT LHS BEFORE HOOKUP, THE PIN HANDLE CAN **PUNCTURE** THE CONDENSER AS THE HOOK ARM LIFTS THE MTRCS.

If pin is facing backwards...

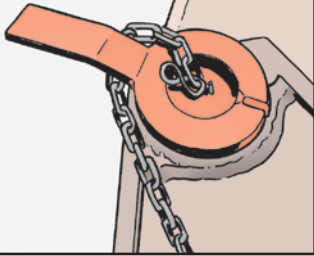

...when hook arm lifts MTRCS...

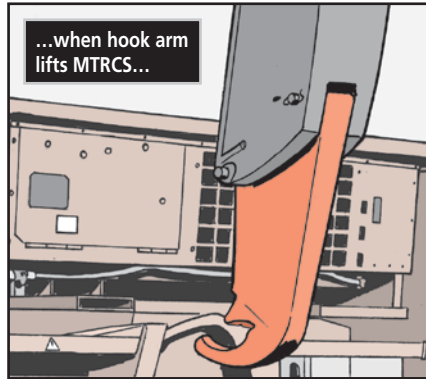

...the condenser is damaged

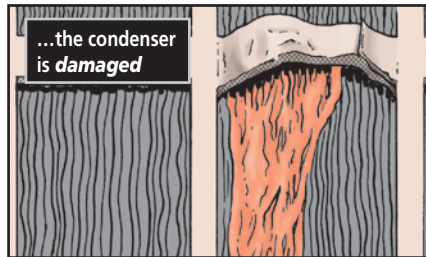

IT COSTS MORE THAN \$9K TO REPLACE THE CONDENSER, WHICH *ISN'T* EASY TO GET.

IT'S SIMPLE TO PREVENT CONDENSER DAMAGE!

Pin should be flush with hook arm

BEFORE ATTACHING THE HOOK ARM TO THE MTRCS BALE BAR, MAKE SURE THE HOOK ARM PIN IS POINTING UP SO IT'S FLUSH AND ALIGNED WITH THE HOOK ARM.

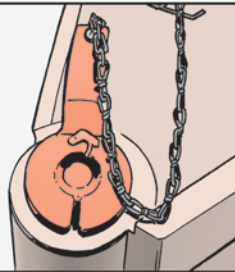

CHECK FOR BATTERY BOX COVER DURING PMCS

WITHOUT THE COVER, WATER CAN FILL THE WHOLE BATTERY BOX AND SHORT OUT THE SYSTEM.

NO COVER MEANS THE MTRCS IS NMC IF THE COVER IS MISSING, REPLACE THE PLASTIC BATTERY BOX AND COVER WITH NSN 6160-01-575-5668.

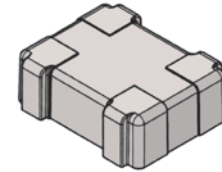

Check for battery box cover

SET TEMPERATURES CORRECTLY

HEY! DO YOU WANT ME TO REFRIGERATE OR FREEZE? MAKE UP YOUR MIND!

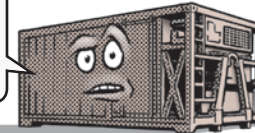

SINCE THE MTRCS HAS REFRIGERATOR AND FREEZER COMPARTMENTS, IT'S CRITICAL YOU SET THE TEMPERATURES FOR BOTH COMPARTMENTS CORRECTLY. THE REFRIGERATED COMPARTMENT SHOULD BE SET TO 35°F AND THE FREEZER COMPARTMENT TO -5°F.

IF YOU **DON'T** SET THE TEMPERATURES CORRECTLY, YOU COULD HAVE A TRAILER OF SPOILED FOOD WHEN YOU GET TO THE FIELD.

IF YOU REMOVE THE PARTITION SEPARATING THE COMPARTMENTS, YOU **MUST** ADJUST BOTH COMPARTMENT SETTINGS SO THAT THE ENTIRE MTRCS ACTS AS EITHER A REFRIGERATOR OR A FREEZER.

OTHERWISE, THE TWO COMPARTMENTS WORK AGAINST EACH OTHER AND THE ENTIRE SYSTEM MAY SHUT DOWN.

SEE WP 0008 IN TM 10-8145-222-10 FOR INFO ON SETTING TEMPERATURE.

EASY CLEAN UP

Wash out with high-pressure hose



AT THE END OF A MISSION, THE MTRCS MUST BE CLEANED AND SANITIZED **BEFORE** IT'S TURNED IN.

THE **EASIEST** WAY TO CLEAN OUT GUNK IS A TRIP TO THE WASH RACK. USE A HIGH-PRESSURE HOSE TO WASH IT OUT, BUT **DON'T** DIRECTLY SPRAY HIGH-PRESSURE WATER INTO THE EVAPORATORS. MAKE SURE TO OPEN THE FLOOR DRAINS. THEN SCRUB IT OUT WITH BLEACH AND WATER.

WHEN YOU'RE FINISHED SCRUBBING, RINSE IT OUT AGAIN WITH WATER. LET THE INSIDE OF THE CONTAINER AIR DRY BEFORE CLOSING THE DOORS TO PREVENT MOLD.

WP 0029 IN THE -10 TM HAS MORE INFO ON CLEANING.

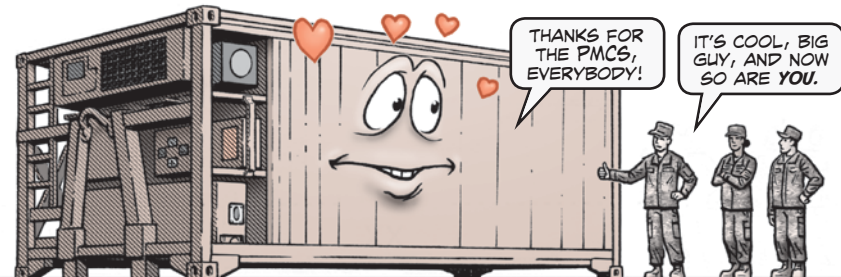

Safety...

FIRE EXTINGUISHERS RECALLED!

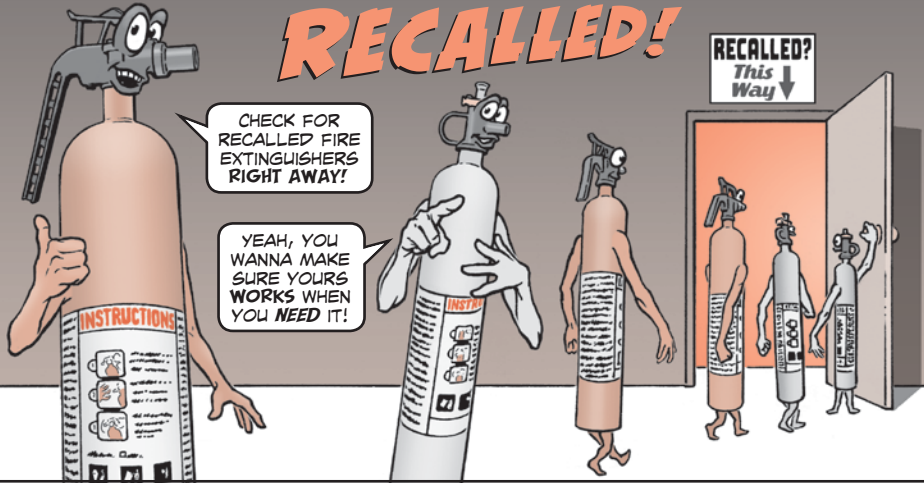

CHECK FOR RECALLED FIRE EXTINGUISHERS RIGHT AWAY!

YEAH, YOU WANNA MAKE SURE YOURS WORKS WHEN YOU NEED IT!

NEARLY 40 MILLION FIRE EXTINGUISHERS ARE BEING RECALLED, AND THERE'S A GOOD CHANCE ONE OF THEM'S IN YOUR HOUSE, APARTMENT, OFFICE OR VEHICLE.

THE FIRE EXTINGUISHERS ARE BEING RECALLED BECAUSE OF **CLOGGING**. THAT MEANS YOUR FIRE EXTINGUISHER MIGHT **NOT** WORK WHEN YOU NEED IT MOST. ALSO, THE NOZZLE CAN BLOW OFF DURING A DISCHARGE WITH ENOUGH FORCE THAT SOMEONE COULD GET HURT.

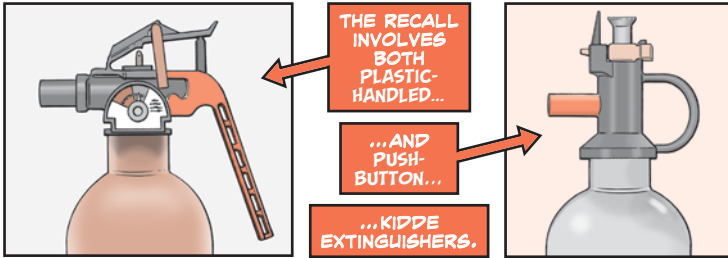

THE RECALL **DOES NOT INCLUDE** KIDDE PROFESSIONAL OR BADGER-BRANDED EXTINGUISHERS.

EXTINGUISHERS WITH METAL HANDLES AND VALVE ASSEMBLIES ARE **NOT INCLUDED** IN THE RECALL. AUTOMATIC FIRE EXTINGUISHING/SUPPRESSION SYSTEM (AFES/AFSS) BOTTLES ARE **ALSO NOT INCLUDED** IN THE RECALL.

FOR INFO ON HOW TO DETERMINE IF YOU HAVE A RECALLED EXTINGUISHER, CHECK OUT TACOM GROUND PRECAUTIONARY ACTION MESSAGE 18-004: <https://tulsa.tacom.army.mil/Safety/message.cfm?id=GPA18-004.html>

IF YOU HAVE A RECALLED EXTINGUISHER, GET A **FREE REPLACEMENT** BY CONTACTING THE MANUFACTURER AT:

<https://inmarmarketaction.com/kidde/>

YOU'LL NEED THE SERIAL AND MODEL NUMBERS, AS WELL AS THE DATE CODE IF THE EXTINGUISHER HAS ONE.

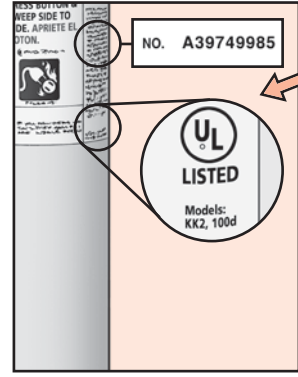

To replace a recalled extinguisher, you will need serial number and model number...

...and date code if extinguisher was made in 2007 or later

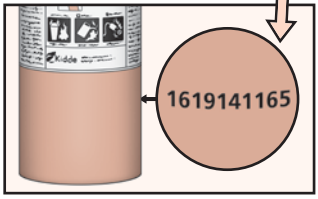

Turn In ECHs with Sensors

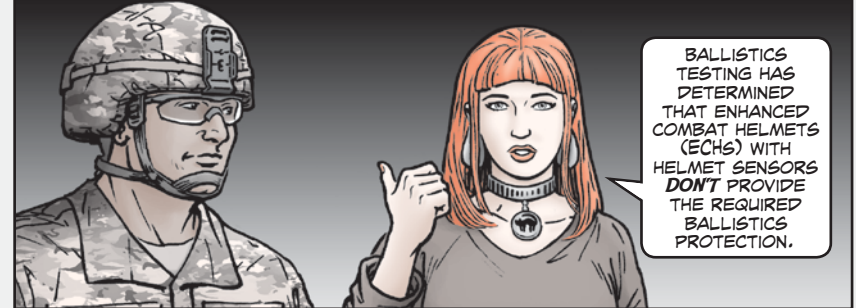

BALLISTICS TESTING HAS DETERMINED THAT ENHANCED COMBAT HELMETS (ECHs) WITH HELMET SENSORS **DON'T** PROVIDE THE REQUIRED BALLISTICS PROTECTION.

IF THE ECH BALLISTICS PROTECTION FAILS, FRAGMENTS OR WHOLE ROUNDS COULD PENETRATE THE HELMET, CAUSING INJURY OR DEATH.

IF YOU'VE BEEN ISSUED AN ECH, CHECK IT NOW FOR A HELMET SENSOR.

HERE'S HOW:

REMOVE THE CROWN PAD INSIDE THE HELMET AND LOOK FOR A BLACK, OVAL SHAPED DEVICE ABOUT 4-INCHES LONG BY 2-INCHES WIDE.

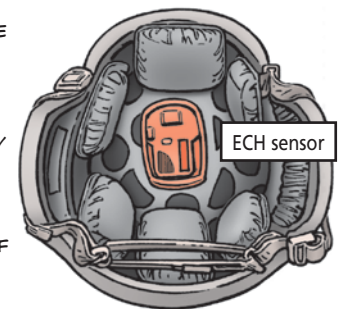

IF YOU FIND ONE, LET YOUR CHAIN OF COMMAND KNOW IMMEDIATELY.

FOR TURN-IN INSTRUCTIONS, CHECK OUT TACOM SAFETY OF USE MESSAGE 18-001:

<https://tulsa.tacom.army.mil/Safety/message.cfm?id=SOU18-001.html>

MELs For Mobile Kitchen Trailers

MOBILE KITCHEN TRAILERS (MKTs) ARE SOME OF THE LONGEST-SERVING EQUIPMENT IN THE FIELD.

BUT THAT *DOESN'T* MEAN THEY'RE EXEMPT FROM THE ARMY'S FISCAL EYE WHEN THE TIME COMES FOR REPAIR.

A ONE-TIME REPAIR EXPENDITURE LIMIT APPLIES EACH TIME A PIECE OF ARMY EQUIPMENT IS DEEMED UNSERVICEABLE. THIS MAINTENANCE EXPENDITURE LIMIT (MEL) IS A PERCENTAGE OF THE TOTAL REPAIR COST ESTIMATE TO THE TOTAL COST OF THE END ITEM.

THE CURRENT MMDF PRICE FOR THE MKT IS \$145,000. THIS IS FOR NSNs 7360-01-483-8617 AND 7360-01-500-4644, LIN L28351.

CHECK THE CHART FOR THE CURRENT MEL PERCENTAGES FOR THE MKT:

MKT age	1-5 yrs	6-8 yrs	9-12 yrs	13-15 yrs	16-20 yrs
MEL %	50	45	35	25	10
Max amount	\$72,000	\$62,500	\$50,750	\$36,250	\$14,500

FOR MORE INFORMATION, SEE TB 43-0002-22 (MAY 95) OR TACOM LCMC'S SUPPLY ADVISORY MESSAGE 18-1008 AT:

<https://tulsa.tacom.army.mil/Safety/message.cfm?id=SAM18-1008.html>

REMEMBER TO CHECK IF I'M ELIGIBLE FOR RETIREMENT!

AMSAA to the Rescue!



WOULDN'T IT BE NICE TO KNOW IF YOU HAD THE RIGHT AMOUNT OF BENCH AND SHOP STOCK TO SUPPORT YOUR NEW AND EXISTING EQUIPMENT?

MAYBE YOU'VE GOT A DEPLOYMENT COMING UP.

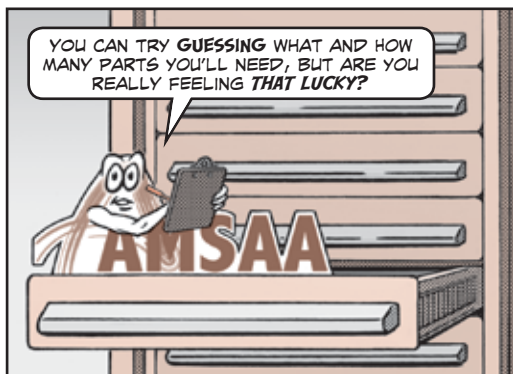

YOU CAN TRY GUESSING WHAT AND HOW MANY PARTS YOU'LL NEED, BUT ARE YOU REALLY FEELING *THAT LUCKY*?

INSTEAD, GO TO THE EXPERTS!

THE ARMY MATERIEL COMMAND (AMC) HAS A GROUP OF ANALYSTS STANDING BY TO ASSIST YOU WITH BENCH AND SHOP STOCK ADVICE.



THE ARMY MATERIEL SYSTEMS ANALYSIS ACTIVITY (AMSAA) CAN PROVIDE YOU WITH SOLUTIONS BASED ON REAL-WORLD DEMAND AND EQUIPMENT DENSITIES.

WITH THEIR HELP, YOU'LL BE ABLE TO MAKE INFORMED DECISIONS ABOUT WHAT YOUR UNIT SHOULD STOCK FOR THE EQUIPMENT ON-HAND.

READY TO GET YOUR BENCH AND SHOP STOCK UNDER CONTROL? EMAIL AMSAA AT: usarmy.apg.amsaa.list.SSL-request@mail.mil

MAKE SURE YOU INCLUDE THE END ITEM'S NIIN (PREFERRED) OR LIN, THE QUANTITY OF EACH END ITEM, AND, IF YOU HAVE MULTIPLE LISTS OR EQUIPMENT LOCATIONS, A BREAK-OUT USING A UNIQUE LABEL SUCH AS A UIC. FOR EXAMPLE:

UIC/Unique Identifier	End Item NIIN/LIN	Qty
ABCDAA	012345678	5
ABCDAA	018765432	15
ABCEAA	012345678	4

The 2018 AAME Draws Nigh

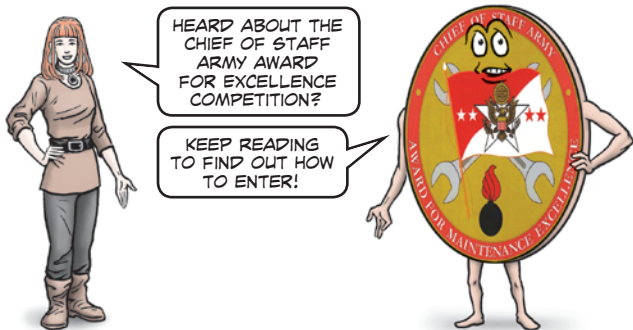

HEARD ABOUT THE CHIEF OF STAFF ARMY AWARD FOR EXCELLENCE COMPETITION?

KEEP READING TO FIND OUT HOW TO ENTER!

The Chief of Staff, Army Award for Maintenance Excellence (AAME) competition recognizes units for exceptional maintenance practices and maintenance readiness.

Your unit is well on its way to competing for an AAME title if it's following the Command Maintenance Discipline Program (CMDP).

Enter for a chance to win and the added benefit of feedback from experts and recommendations to improve your maintenance procedures.

To fill out an AAME entry packet, open the AAME Program Guidelines and follow the instructions:

<https://www.cascom.lee.army.mil/private/ord/aame/FY18-AAME-Guidance.pdf>

The deadline for submission is 1 Nov 18 and you can find more information on the AAME here: <http://www.goordnance.army.mil/AAME/aame.html>

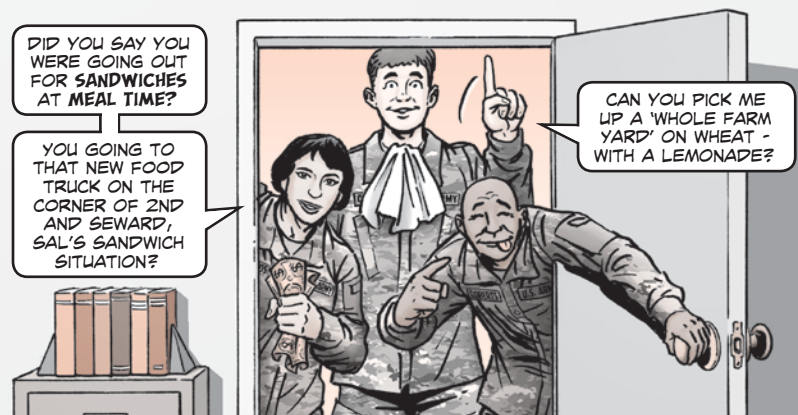

DID YOU SAY YOU WERE GOING OUT FOR SANDWICHES AT MEAL TIME?

YOU GOING TO THAT NEW FOOD TRUCK ON THE CORNER OF 2ND AND SEWARD, SAL'S SANDWICH SITUATION?

CAN YOU PICK ME UP A 'WHOLE FARM YARD' ON WHEAT - WITH A LEMONADE?

GCSS-Army...

WHAT THE HECK IS SANDWICH MEALTIME?

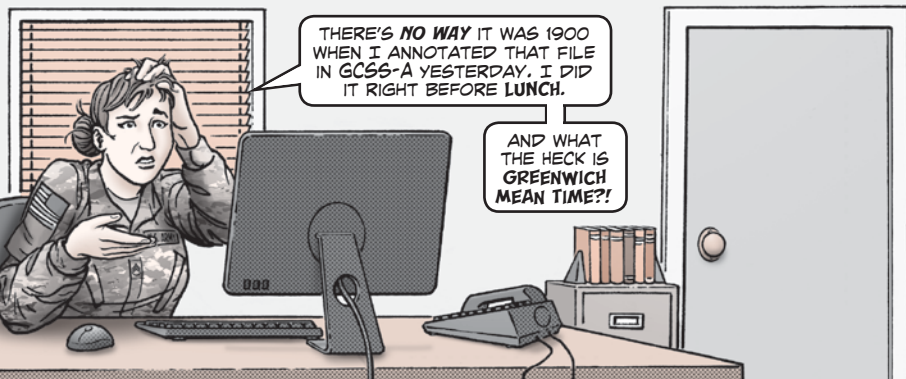

THERE'S **NO WAY** IT WAS 1900 WHEN I ANNOTATED THAT FILE IN GCSS-A YESTERDAY. I DID IT RIGHT BEFORE LUNCH.

AND WHAT THE HECK IS GREENWICH MEAN TIME?!

YOU MIGHT HAVE NOTICED THAT GCSS-ARMY **DOESN'T** USE YOUR LOCAL TIME FOR DATE AND TIME STAMPS.

THAT'S BECAUSE GCSS-A USES THE GREENWICH MEAN TIME (GMT) STANDARD.

USE THIS CHART TO TRANSLATE YOUR LOCAL TIME TO GMT...

GMT	EDT	EST/CDT	CST/MDT	MST/PDT	PST
0000	8 pm	7 pm	6 pm	5 pm	4 pm
0100	9 pm	8 pm	7 pm	6 pm	5 pm
0200	10 pm	9 pm	8 pm	7 pm	6 pm
0300	11 pm	10 pm	9 pm	8 pm	7 pm
0400	Midnight	11 pm	10 pm	9 pm	8 pm
0500	1 am	Midnight	11 pm	10 pm	9 pm
0600	2 am	1 am	Midnight	11 am	10 am
0700	3 am	2 am	1 am	Midnight	11 pm
0800	4 am	3 am	2 am	1 am	Midnight
0900	5 am	4 am	3 am	2 am	1 am
1000	6 am	5 am	4 am	3 am	2 am
1100	7 am	6 am	5 am	4 am	3 am
1200	8 am	7 am	6 am	5 am	4 am
1300	9 am	8 am	7 am	6 am	5 am
1400	10 am	9 am	8 am	7 am	6 am
1500	11 am	10 am	9 am	8 am	7 am
1600	Noon	11 am	10 am	9 am	8 am
1700	1 pm	Noon	11 am	10 am	9 am
1800	2 pm	1 pm	Noon	11 am	10 am
1900	3 pm	2 pm	1 pm	Noon	11 am
2000	4 pm	3 pm	2 pm	1 pm	Noon
2100	5 pm	4 pm	3 pm	2 pm	1 pm
2200	6 pm	5 pm	4 pm	3 pm	2 pm
2300	7 pm	6 pm	5 pm	4 pm	3 pm

Bad HR BOM?

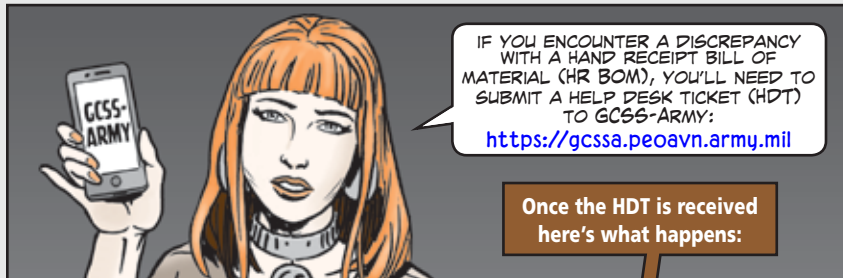

Once the HDT is received here's what happens:

1. AMC LOGSA forwards the HDT to the appropriate organization.
2. The responsible life cycle management command and program manager (LCMC/PM) will contact the customer within 48 hours with the correct source to fix the discrepancy.
3. If the problem is with the BOM in GCSS-Army, the responsible organization will correct the HR BOM in 5-10 business days and load it into the Logistics Product Data Store (LPDS) for entry into GCSS-Army.
4. The LCMC/PM will load the BOM into GCSS-Army.

Download GCSS-A Supply Smartbook

Work in supply and have questions about getting started with GCSS-A? Download the *GCSS-A Supply Smart Book*. The smart book contains information about GCSS-A document numbers, storage code types, common movement types and more. Download the smart book at: https://gcss.army.mil/Documents/Library/SSA_Smart_Book.pdf

Connie's POST PS SCRIPTS



SINCE FOURTEEN-HUNDRED AND NINETY-TWO, WHEN COLUMBUS SAILED THE OCEAN BLUE, IT TOOK LOTS OF PM, NOT WISHPFUL THINKING, TO KEEP OL' CHRIS' SHIPS FROM SINKING!

GCSS-A Training Requests

If you have questions about GCSS-Army but can't find answers, submit a training request to the GCSS-A team at this address:

usarmy.lee.peo-eis.mbx.gcass-army-training@mail.mil

Include your name, organization, fielding group and RIC in the body of the email. For the subject line, use Training Tab Inquiries.

LRT-110 Crane Seat Rail Kit

Get a new seat rail parts kit for the 7 1/2-ton LRT-110 crane with NSN 2540-01-302-3524. The new kit is a replacement for the seat rails shown as Item 7 in Fig 113 of TM 5-3810-305-24P (Sep 12).

A1P2 FMTV Turn Signal Switch

Need a new turn signal switch for your A1P2 FMTV? Don't order the whole steering column! Instead, order a turn signal switch kit with NSN 2540-01-645-2402. Make a note until the kit is added to TM 9-2320-333-13&P (Jun 15).

FIRE EXTINGUISHER SERVICE LIFE EXTENDED

The service life of the M1-series tank's water potassium acetate (WKA) portable fire extinguisher, NSN 4210-01-519-0942, is officially extended from five to 12 years. Since each extinguisher costs about \$650, the extended service life will save your unit some big bucks over the years.

Would You Stake Your Life ^{right now} on the Condition of Your Equipment?

CROSS- TRAINING CREATES



I KNOW
YOU TAKE
GOOD CARE
OF ME, BUT
YOU OUGHTA
KNOW HOW
TO MAINTAIN
GENERATORS,
TOO!

WELL- ROUNDED SOLDIERS



C'MON, I'LL
INTRODUCE YA.

'SUP?